

# 1

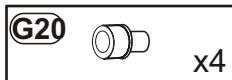

# 2

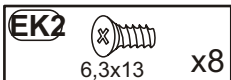
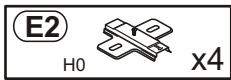
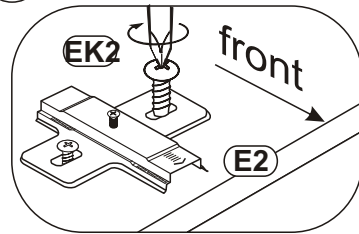
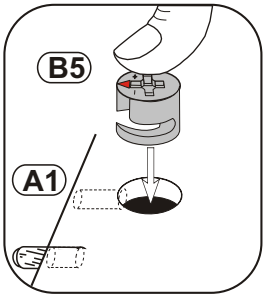
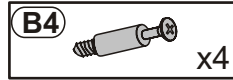
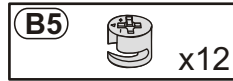
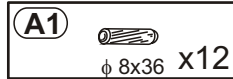
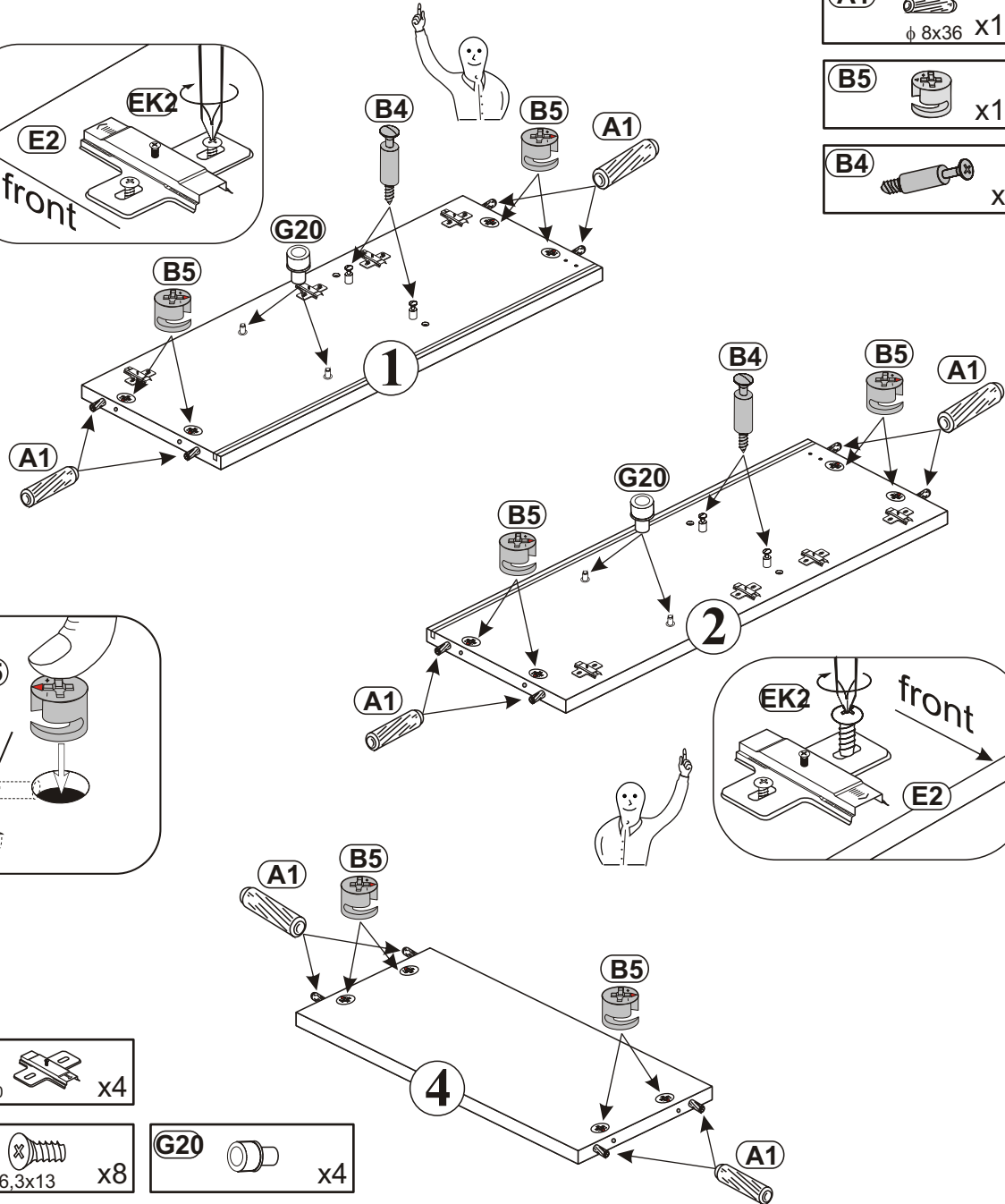
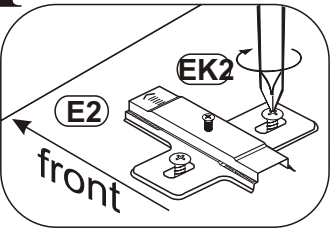
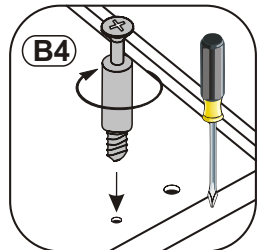
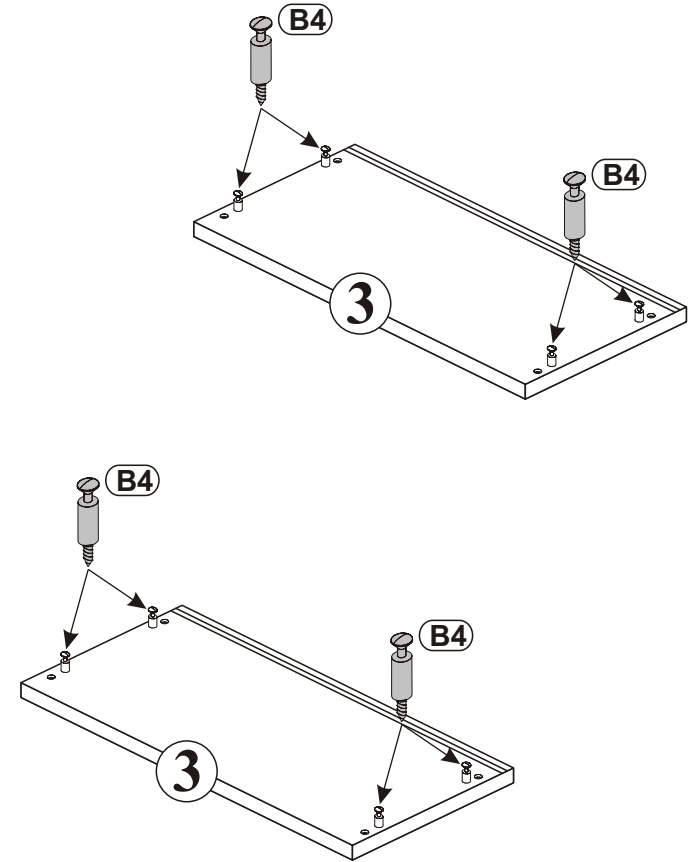
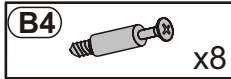

### 3

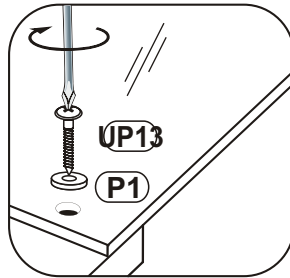
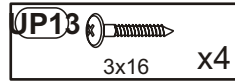
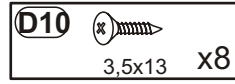
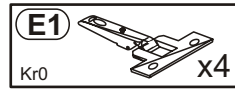
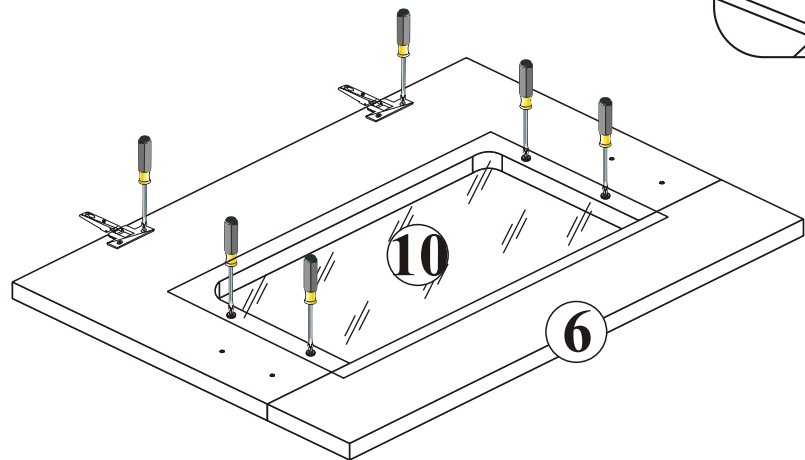
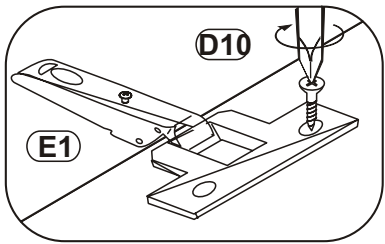
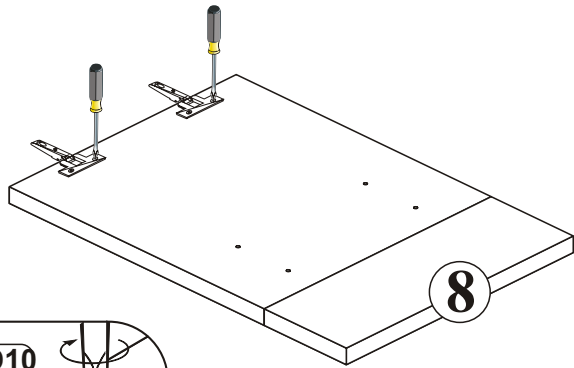

### 4

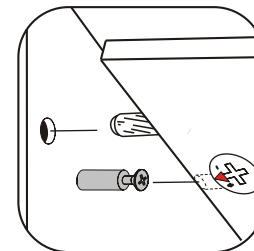
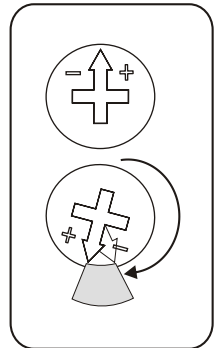
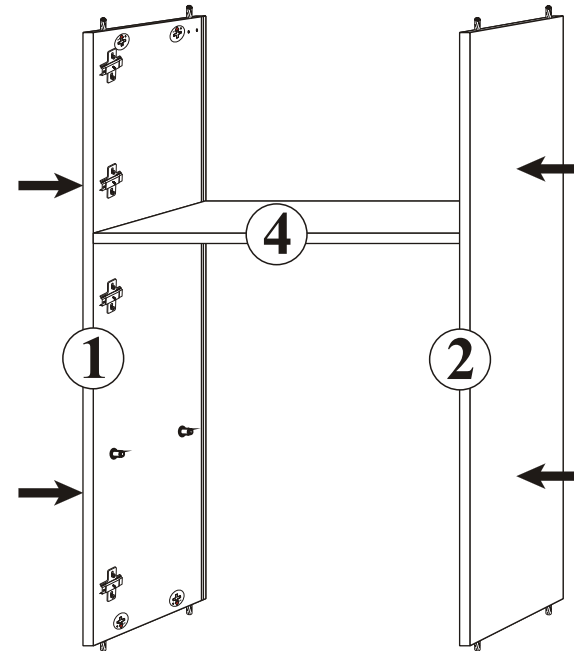

## 5

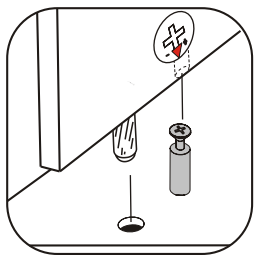
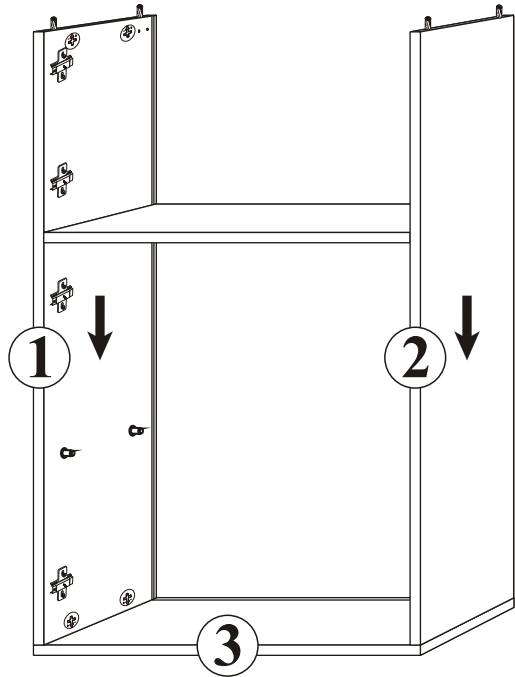

## 6

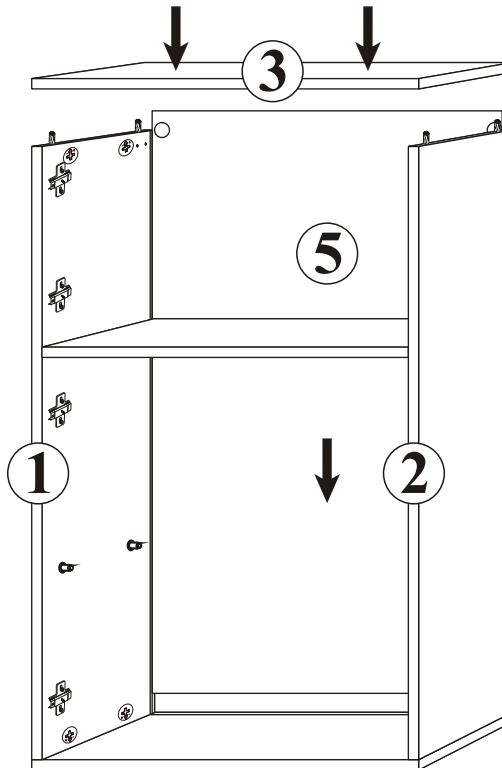
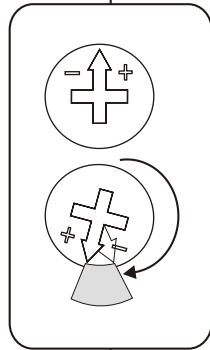
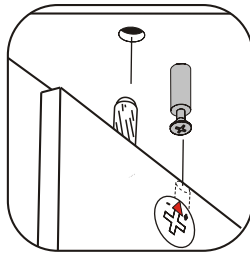

## 7



a=b

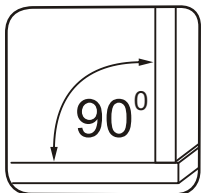
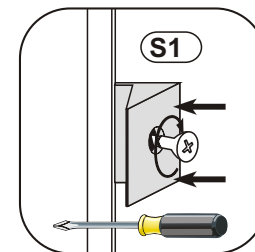
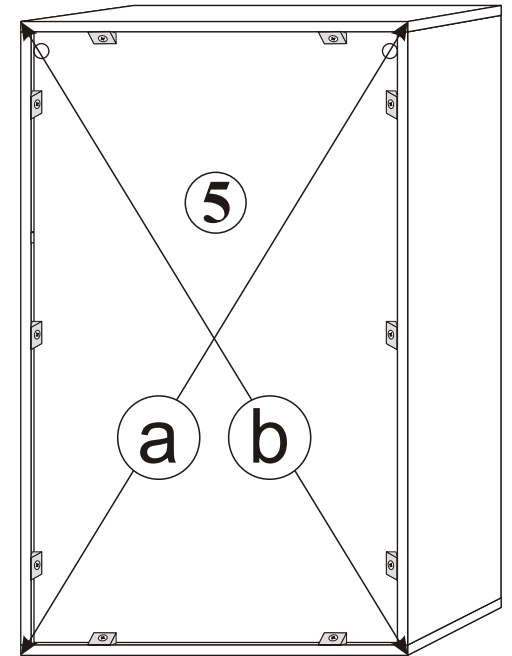

## 8

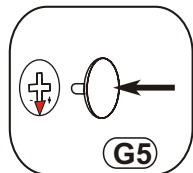
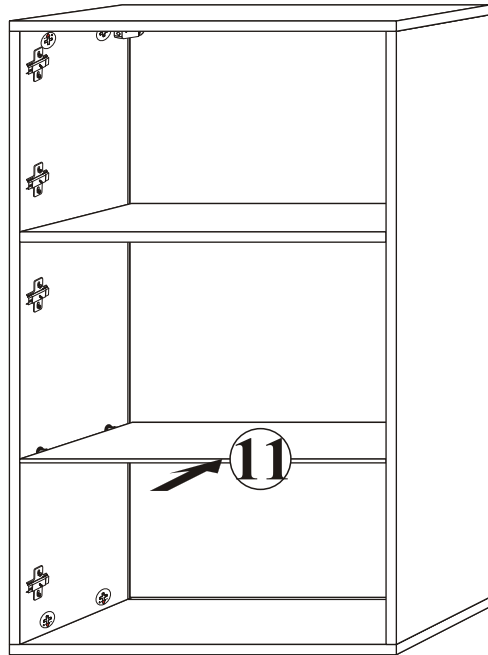
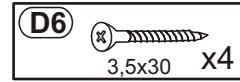
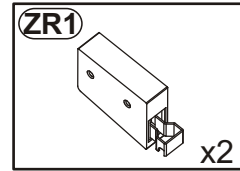
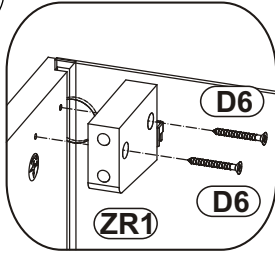

## 9

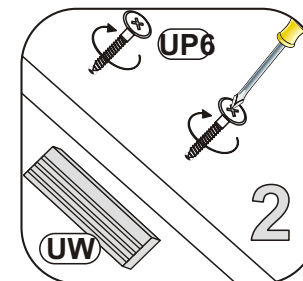
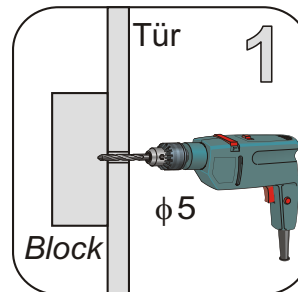
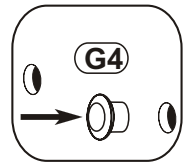
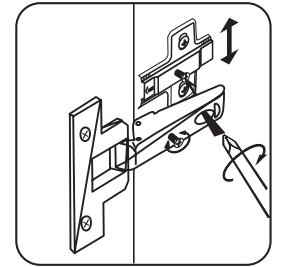
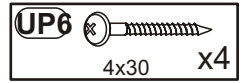
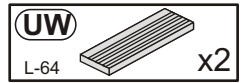
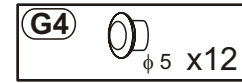
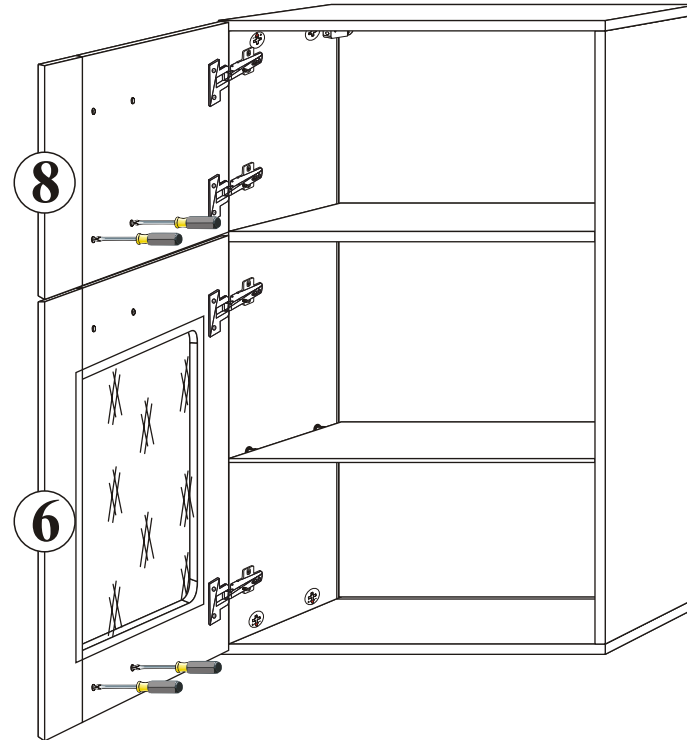

# 10

