

1

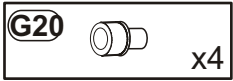

2

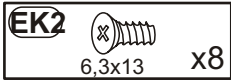
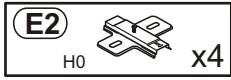
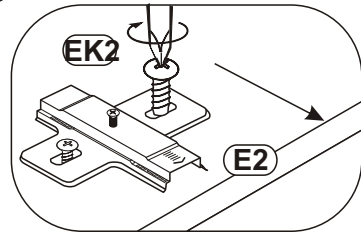
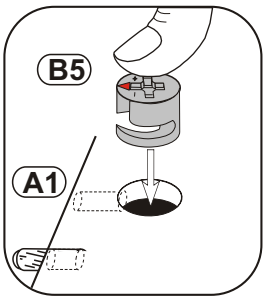
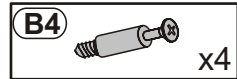
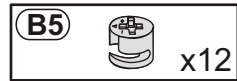
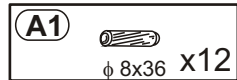
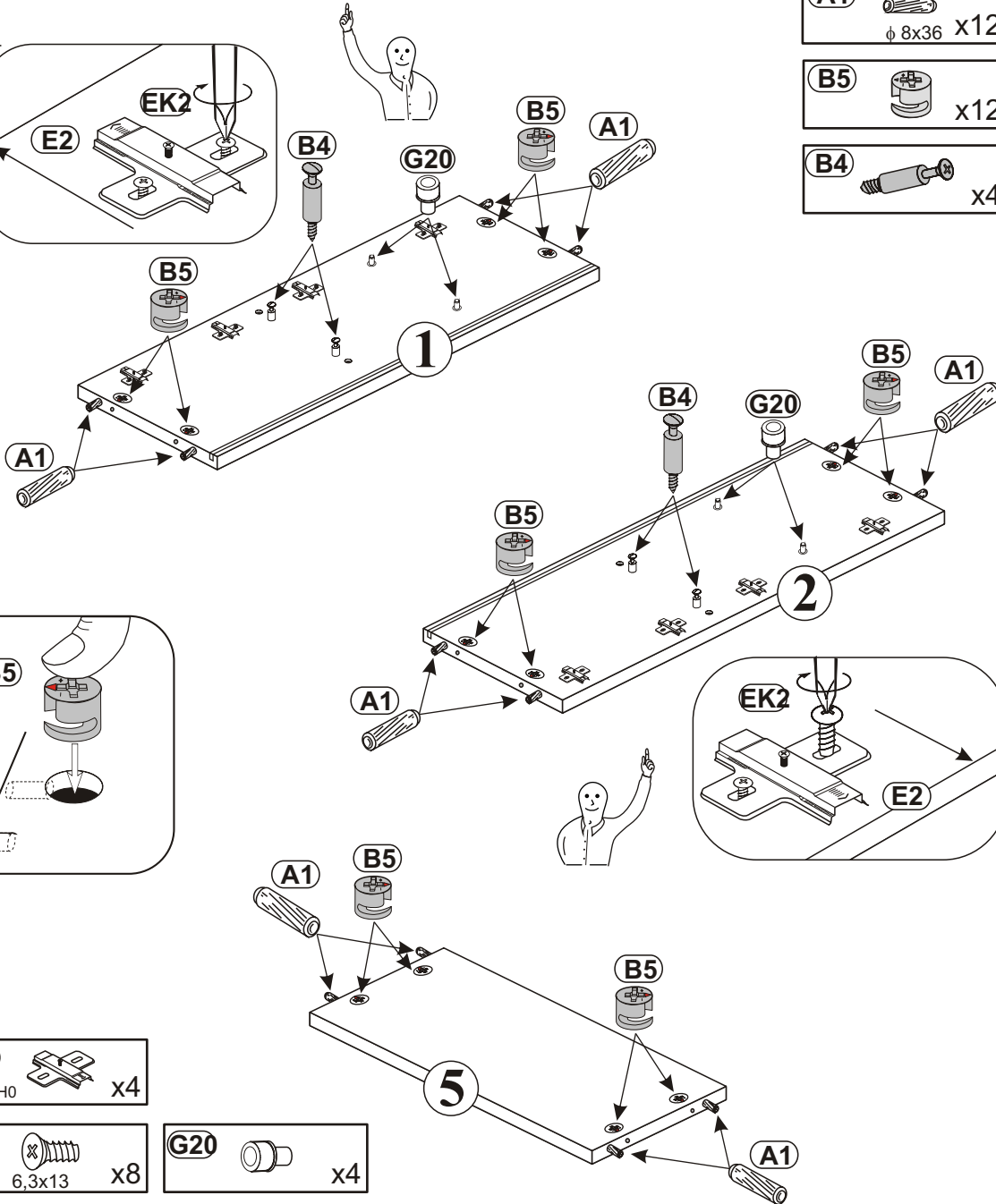
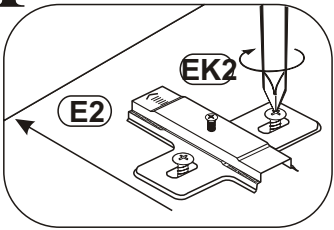
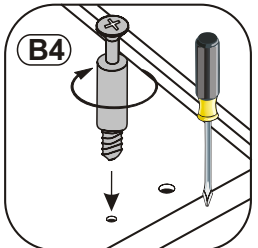
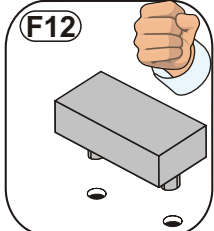
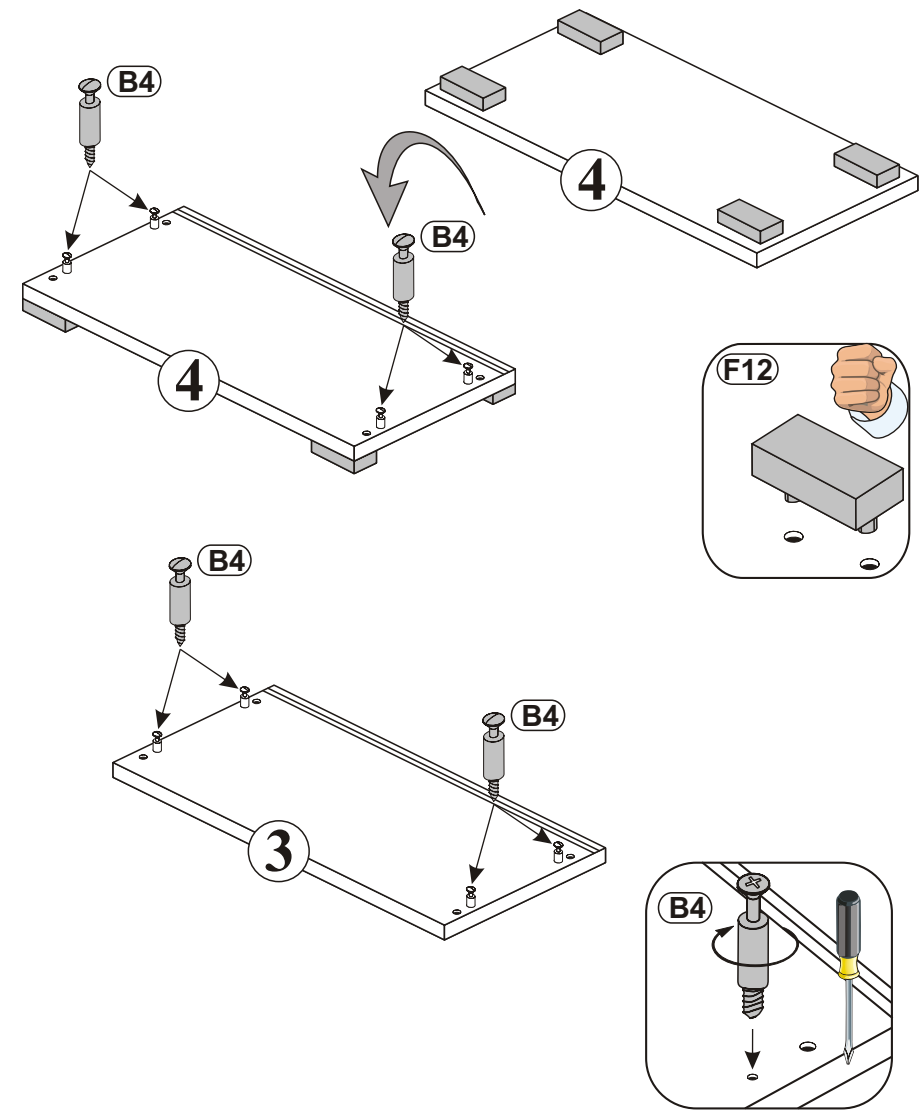
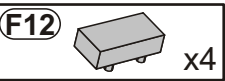
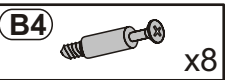

ALLEPO

TYP 40

24 __ AL

3

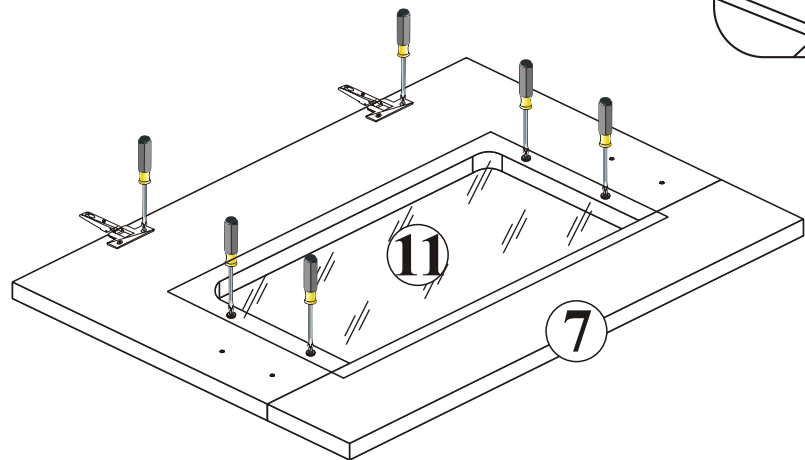
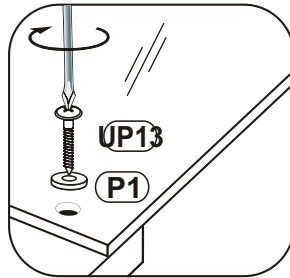
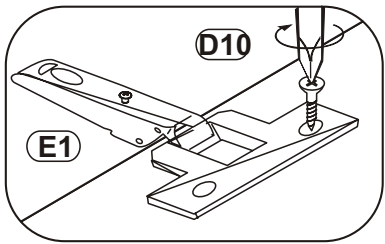
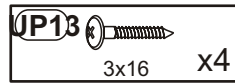
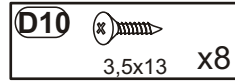
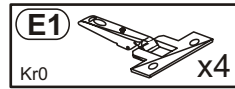
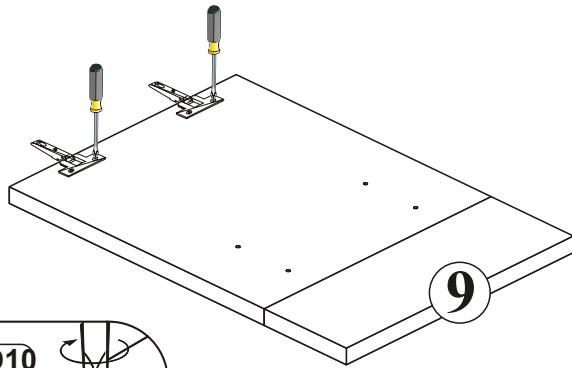

4

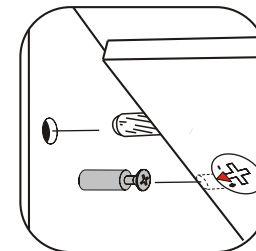
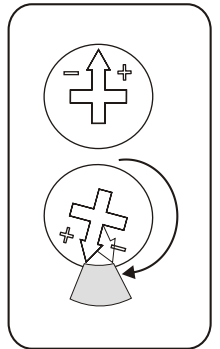
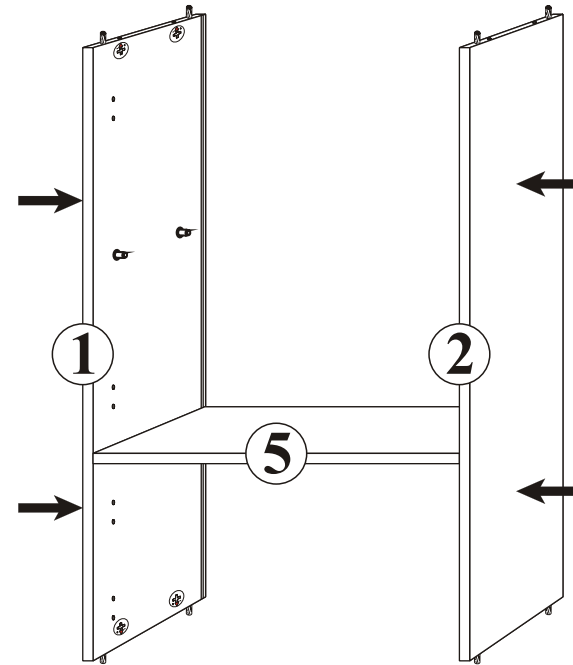

5

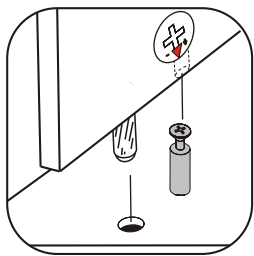
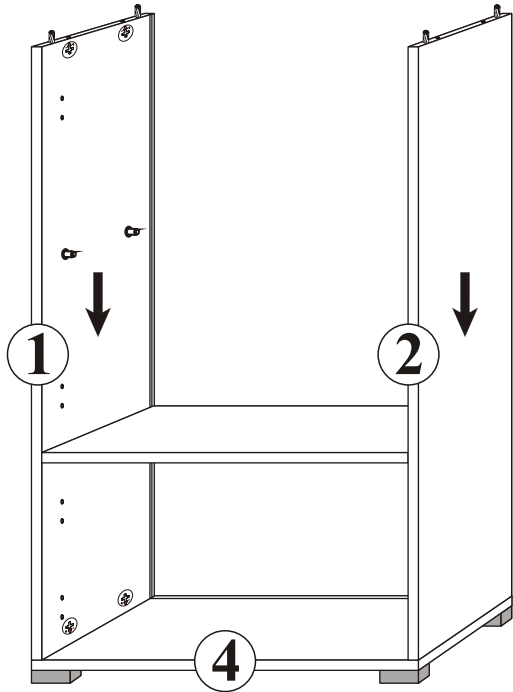

6

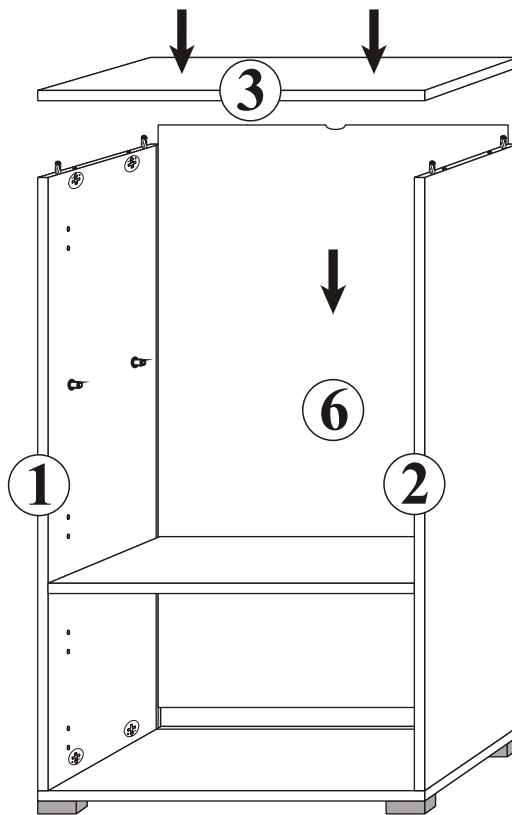
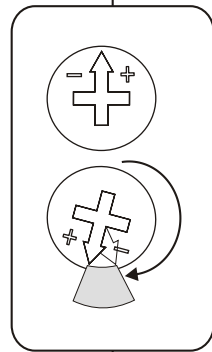
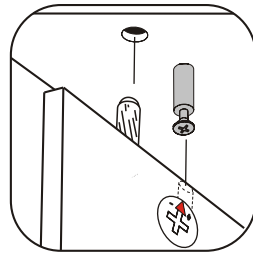

7



a=b

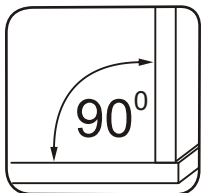
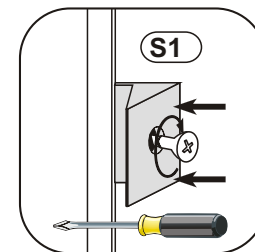
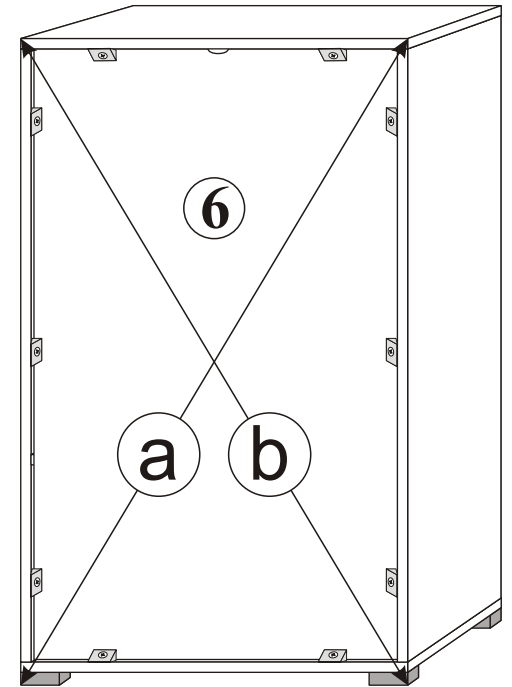

8

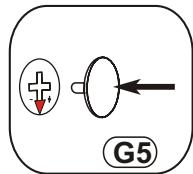
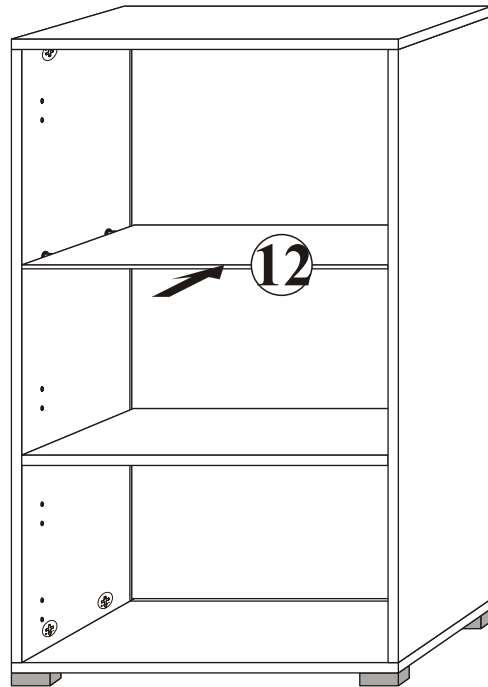

9

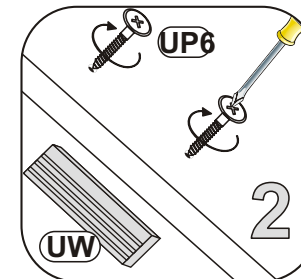
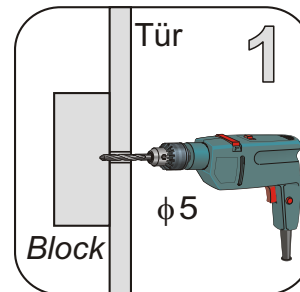
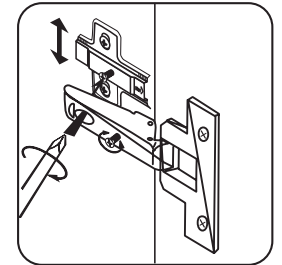
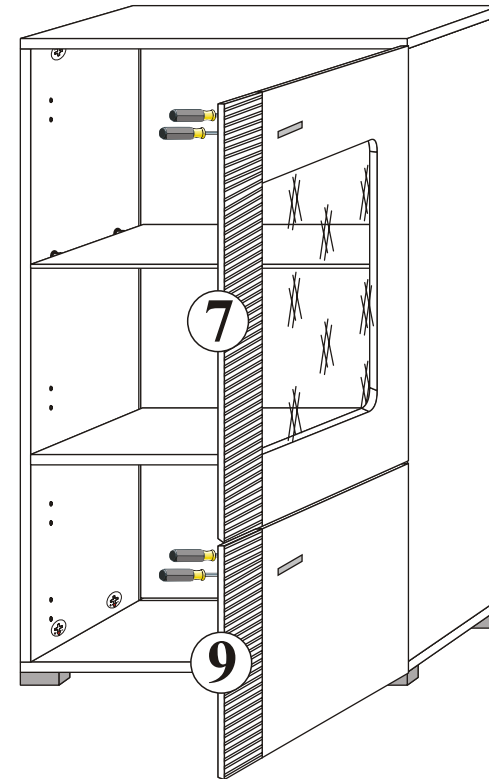
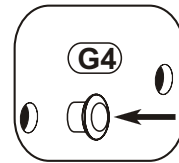
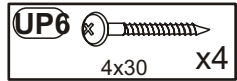
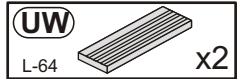
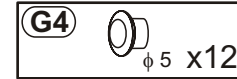

10

