

<p>Nazwa modelu / Model name / Nom du modele / Model-Imam / Nome modello / Název modelu / Modelnaam / Ime modela / Numéro Modelo / Modell neve / Modellname / Názov modelu / Ime modela / Denumire model / Наименование на модела /</p> <h1>BORNEO</h1>	<p>Typ / Tipo / Tipus / Type / Tip</p> <h1>REG-1</h1>	<p>Kolor / Color / Couleur / Farbe</p> <h1>DAŁ ARTISAN/CZARNY</h1>	<p>2023.11.10</p>
---	---	--	-------------------

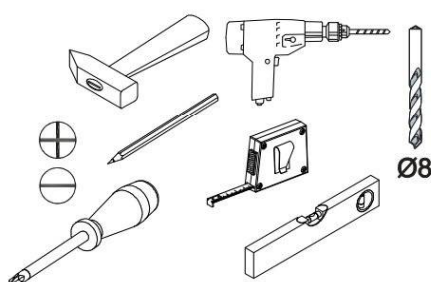
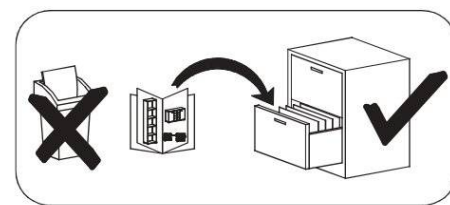
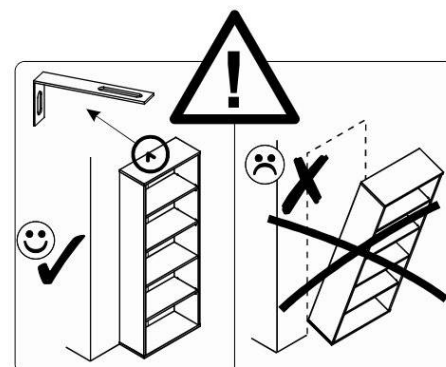
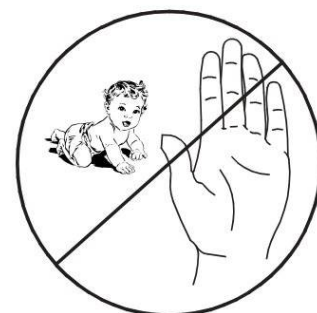
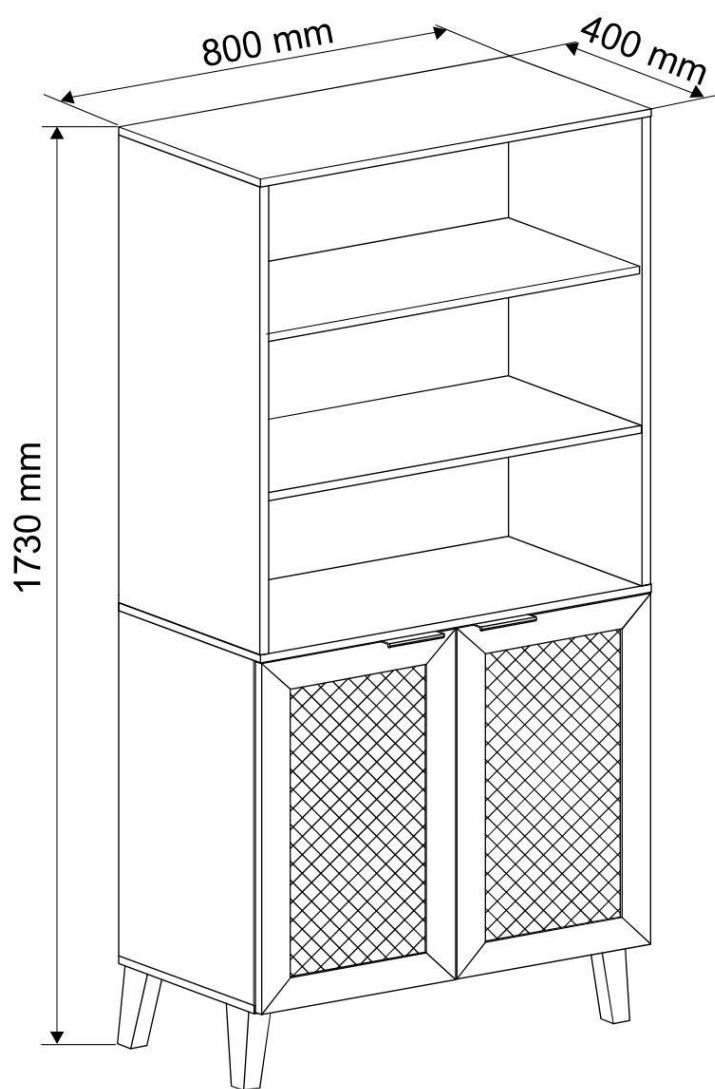
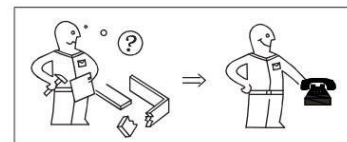
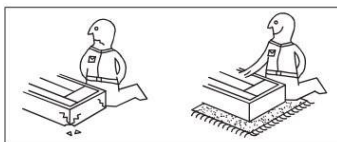
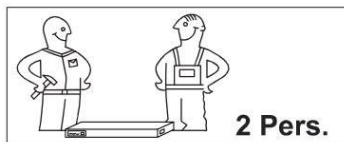

HALMAR

HALMAR Sp. z o.o., ul. Centralnego Okręgu Przemysłowego 2,
37-450 Stalowa Wola, POLSKA / POLAND
tel. +48 15 843 28 10, fax: +48 15 842 19 57, e-mail: office@halmar.com.pl

Modellname / Model name / Nom du modele / Model-Inamn /
Nome modello / Název modelu / Modelnaam / Ime modela /
Numéro Modelo / Modell neve / Название модели /
Názov modelu / Ime modela / Denumire model /
Наименование на модела/ Nazwa modelu

BORNEO

Type / Tipo / Tipus / Typ / Тип

REG-1

Farbe / Color / Couleur / Kolor

DĄB ARTISAN/CZARNY

2023.11.10

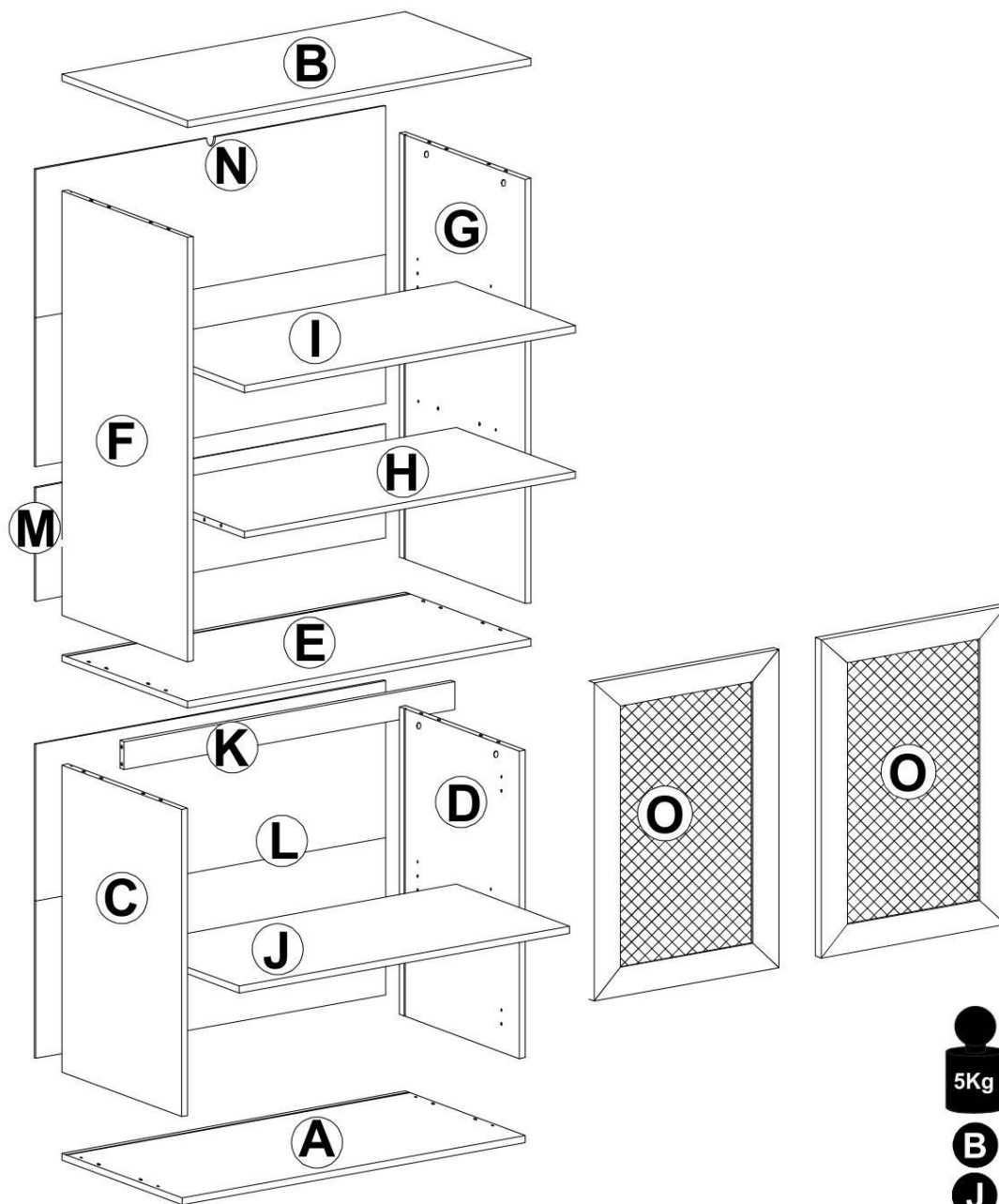

PL Jeżeli brakuje części koniecznych do montażu lub w przypadku innych reklamacji dotyczących mebla, prosimy zgłosić się z kartą serwisową do salonu w którym został dokonany zakup.

D Sollte Ihnen ein Beschlagteil fehlen, oder Sollten Sie eine andere Beanstandung an Ihrem Möbelstück haben, so wenden Sie sich bitte direkt an Ihr Möbelhaus.

GB If parts for assembly are missing or if you, have any other complaints, please contact your furniture store directly

Powód reklamacji / Cause for complaint:

Sklep meblowy / Furniture store:

Klient / Customer:

Telefon / Telephone:

Kod Pocztowy / Postcode:

Miasto / City:

Adres / Street address

@E-Mail:

Modellname / Model name / Nom du modele / Model-Inamn /
Nome modello / Název modelu / Modelnaam / Ime modela /
Número Modelo / Modell neve / Название модели /
Názov modelu / Ime modela / Denumire model /
Наименование на модела/ Nazwa modelu

BORNEO

Type / Tipo / Tipus / Typ / Тип

















REG-1

Farbe / Color / Couleur / Kolor

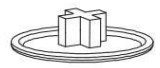
DĄB ARTISAN/CZARNY

2023.11.10

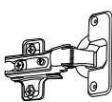
OKUCIA

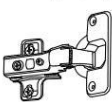
Z6  4mm x1	Z  Ø3,5x20mm x16	Q  Ø3x16mm x14	Z5  Ø15x13mm x14	R  Ø4x40mm x1	T  x1
Z9  x8	Z7  Ø7x50mm x8	Z3  Ø8x30mm x22	Z4  x14	Z1  L-116mm x2	Z8  Ø18mm x12
W  Ø3,5x16mm x8	U  Ø8x40mm x1	S  Ø4x16mm x2	Z2  x28	P+P10  KR-0 x2	X  H-150mm x4
Y+Y10  KR-0 x2					

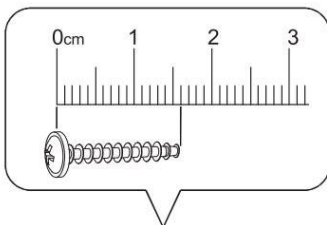

1

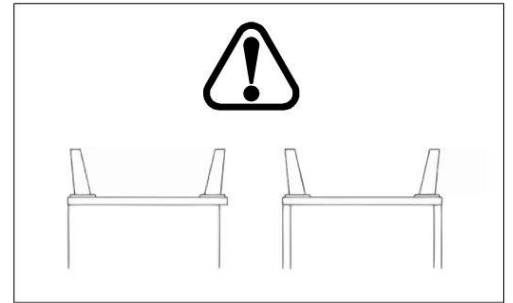
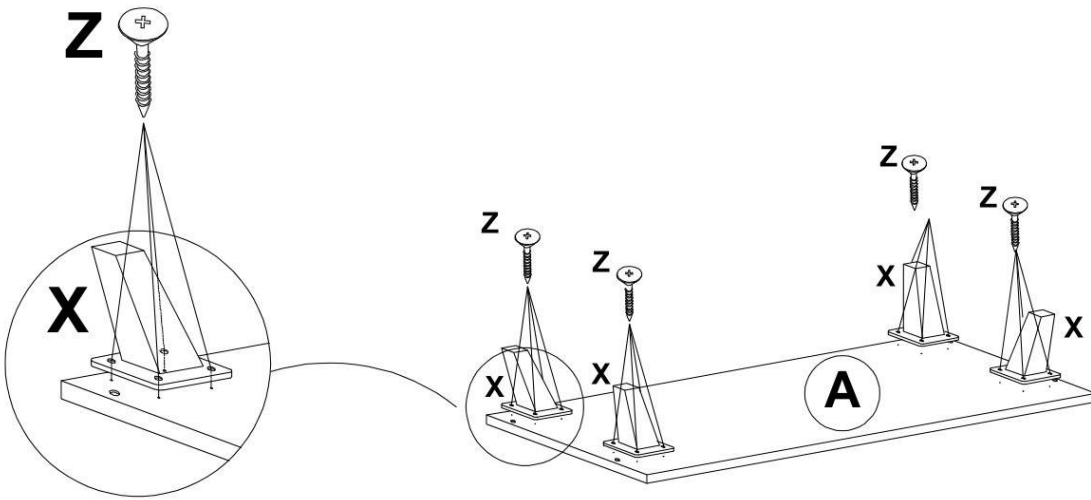
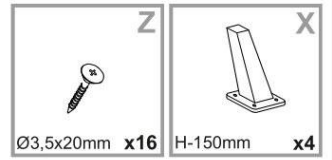
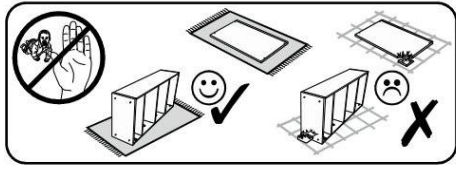

2

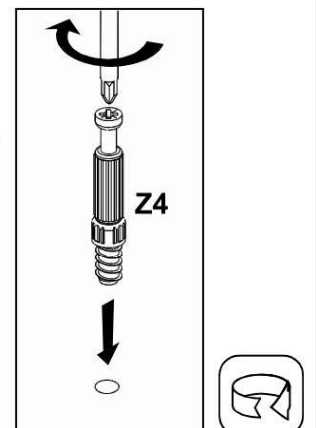
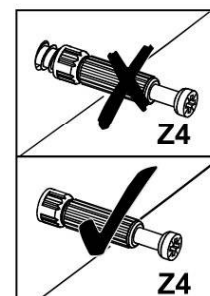
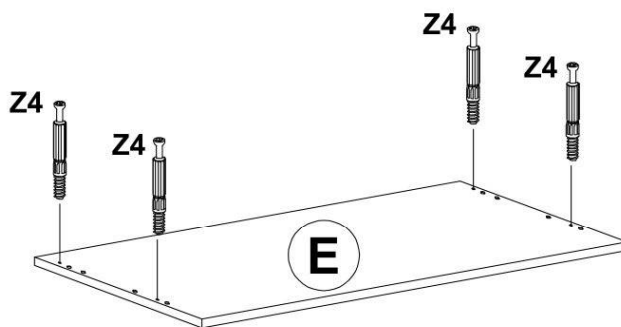
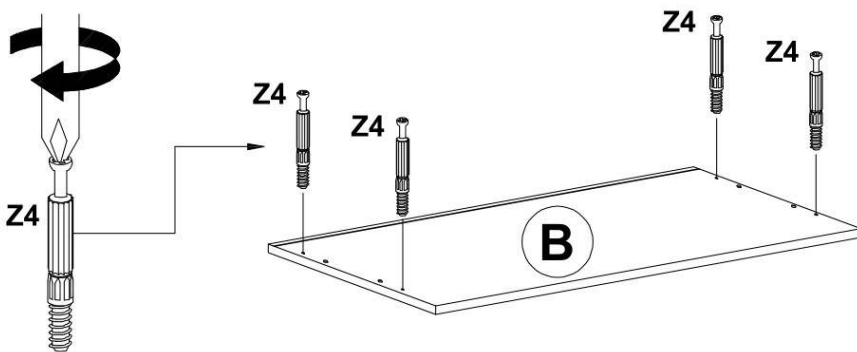
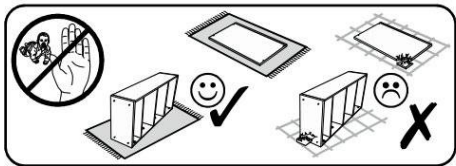

3

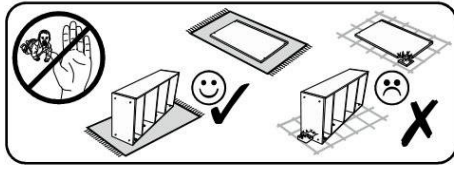

 Z4 x6	 Z3 Ø8x30mm x22	 Z5 Ø15x13mm x14
---	--	---

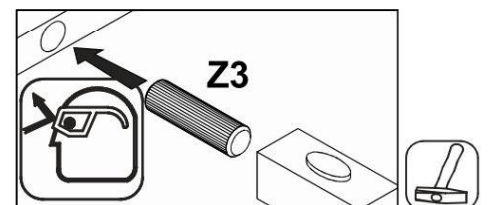
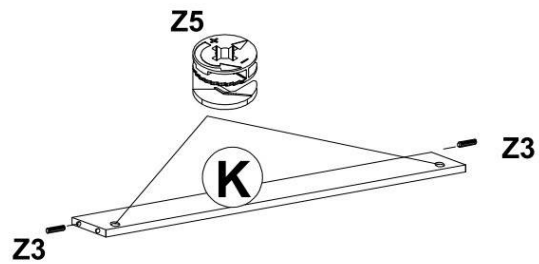
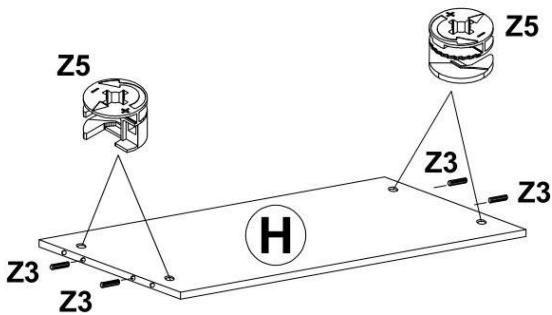
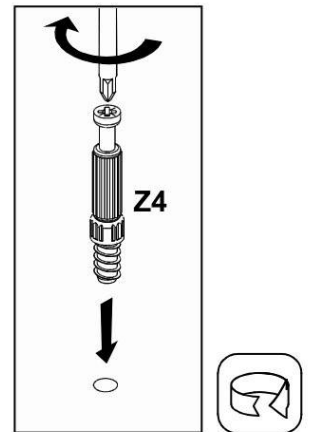
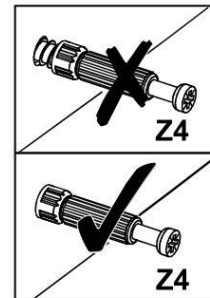
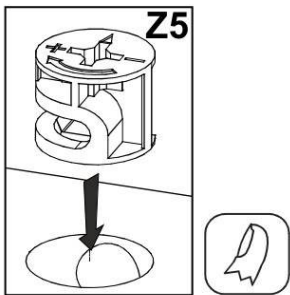
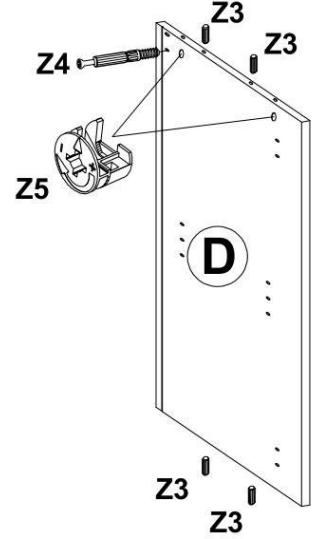
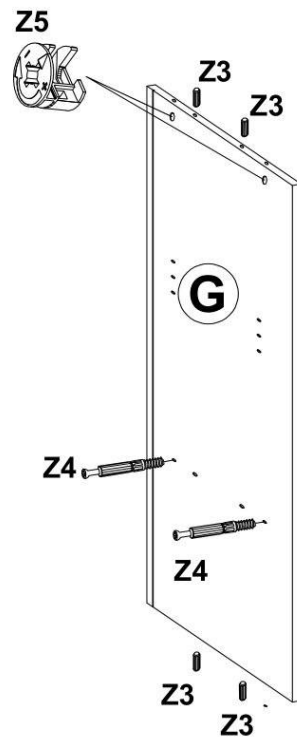
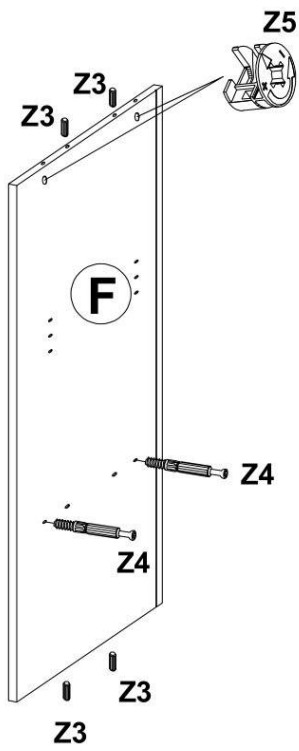
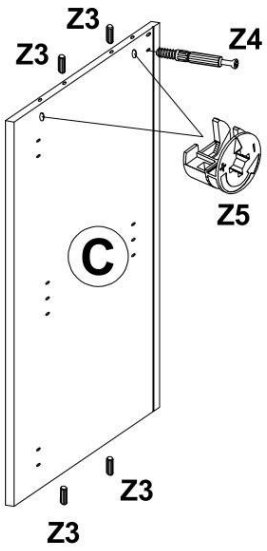

4

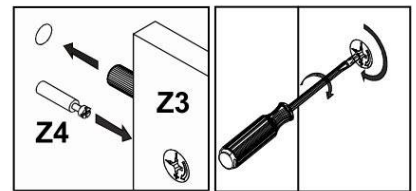
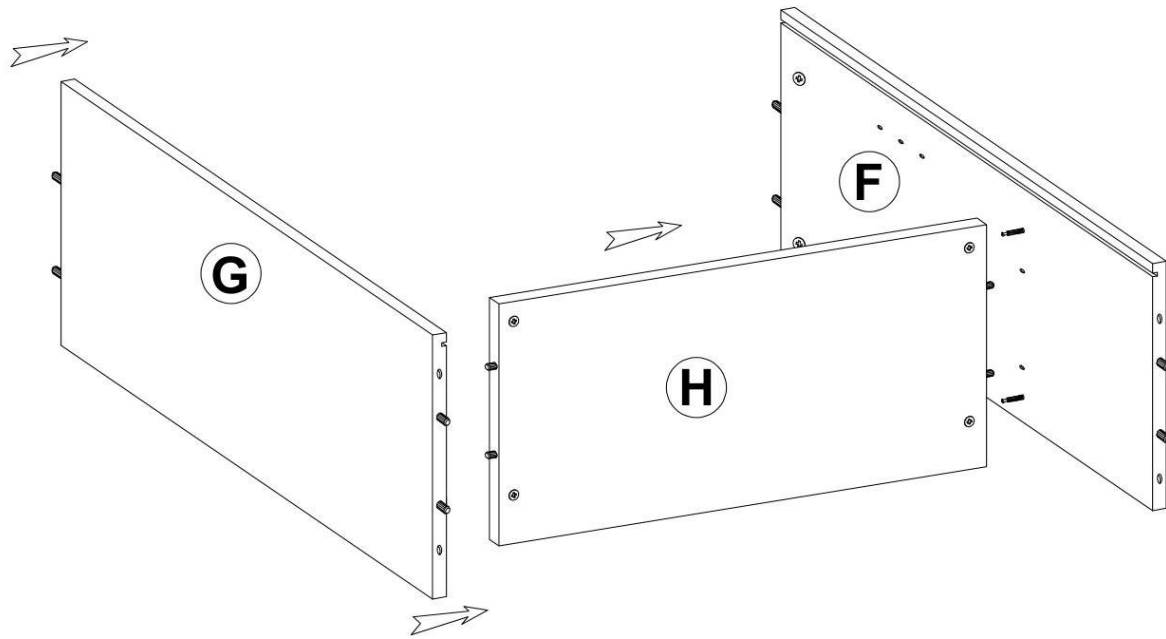

5

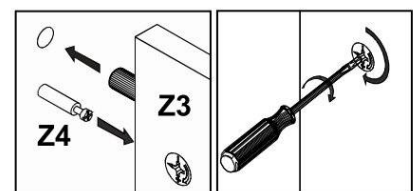
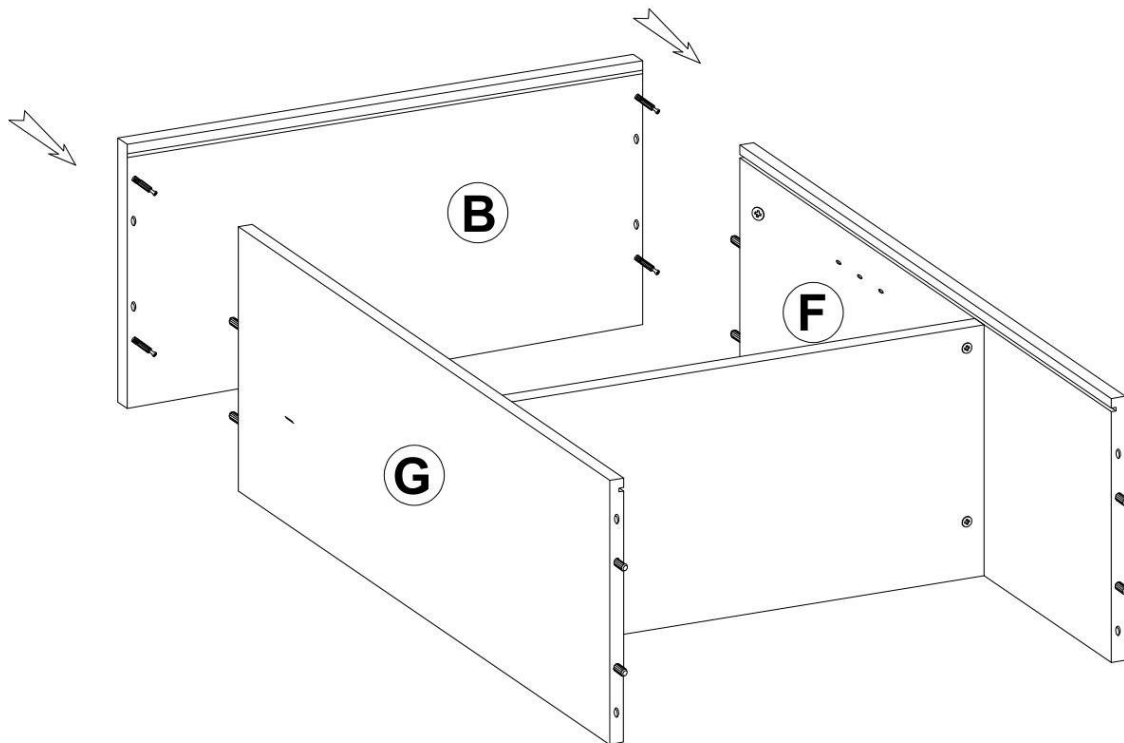

6

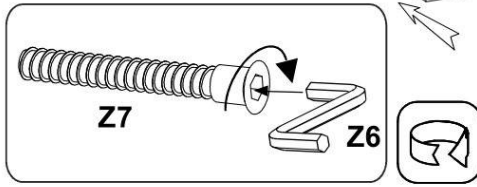
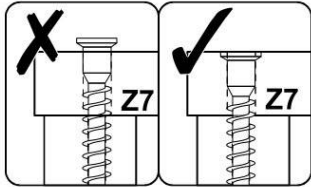
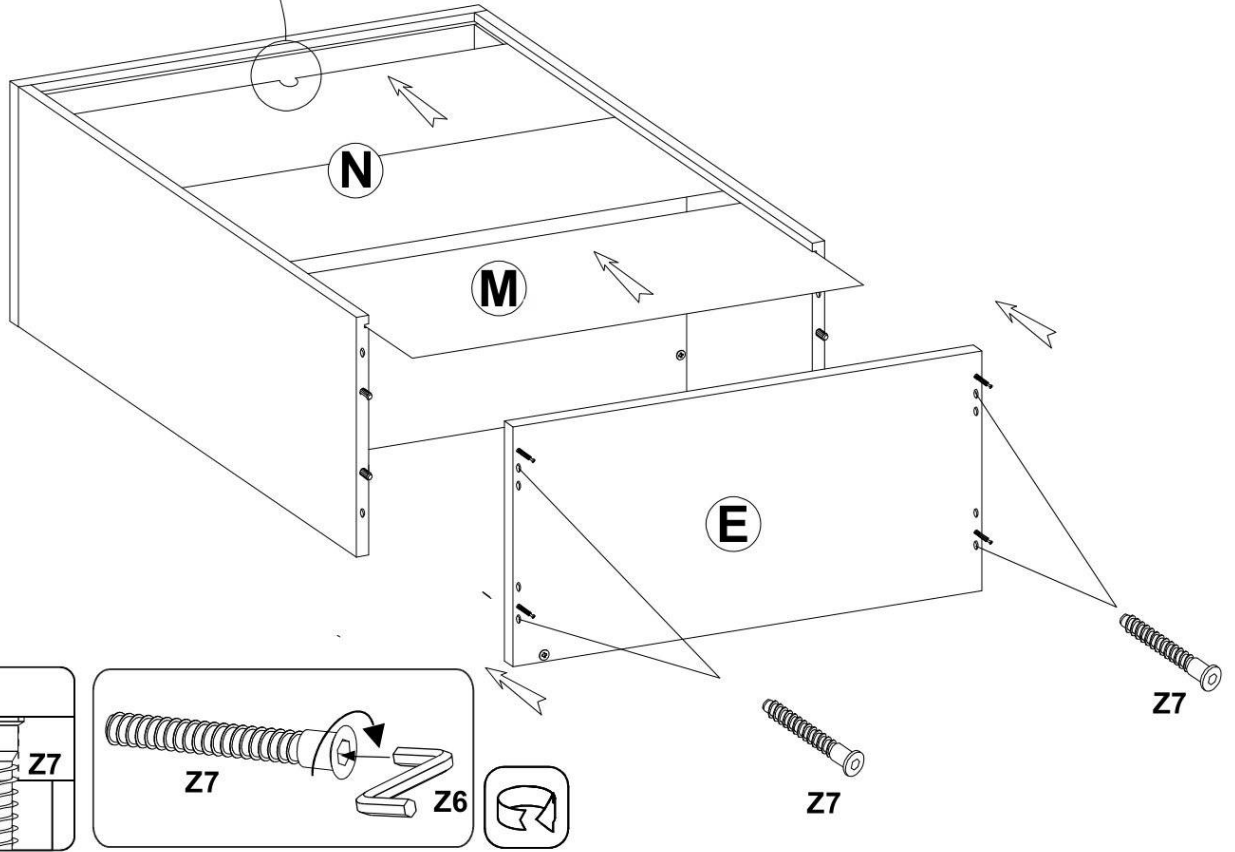
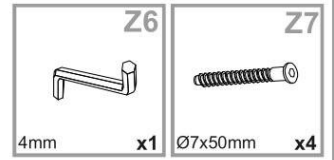
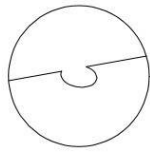

7

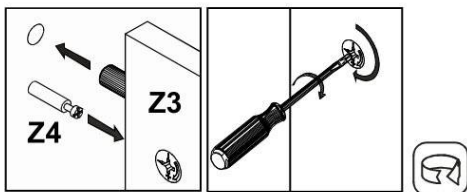
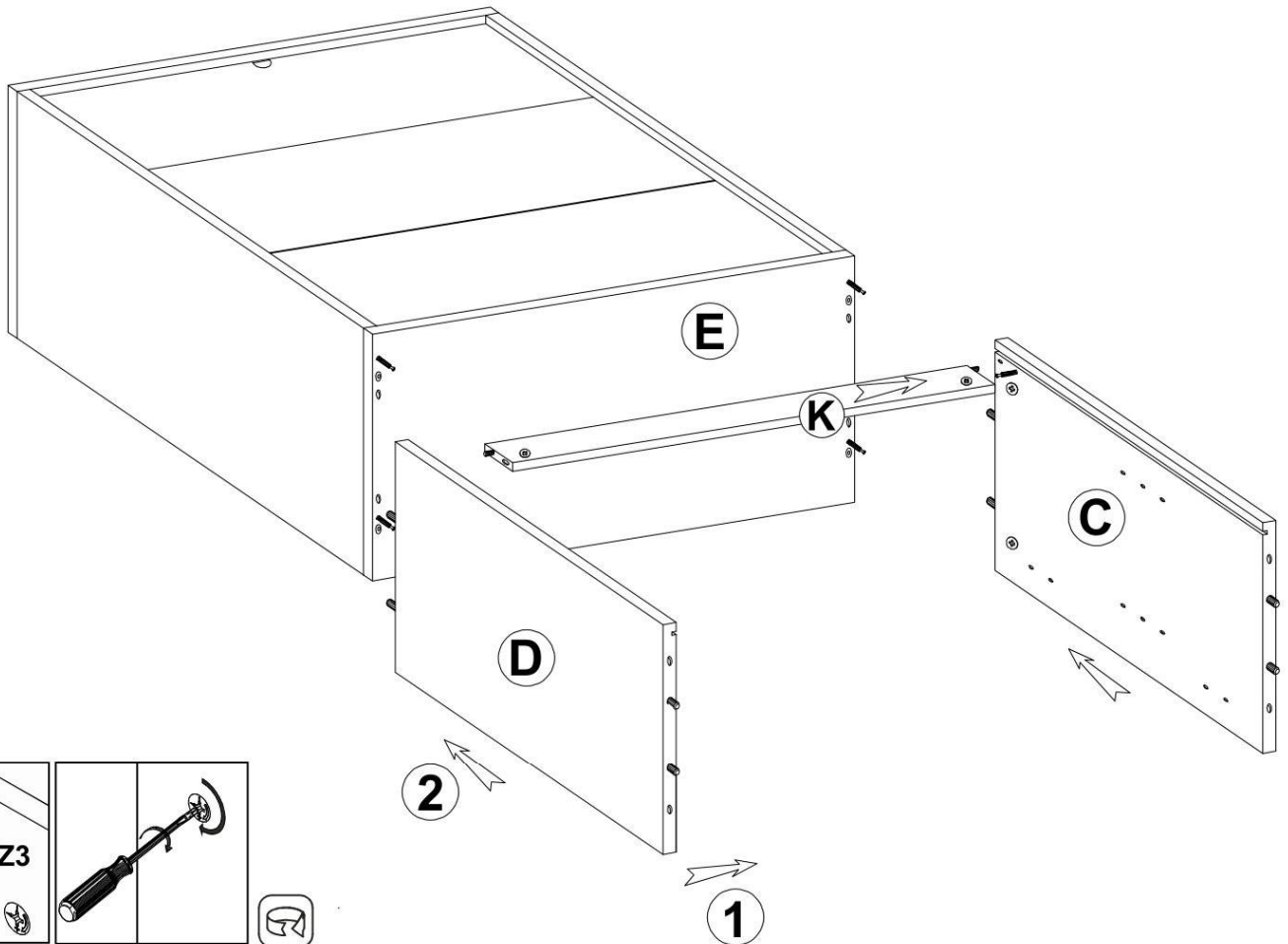

8

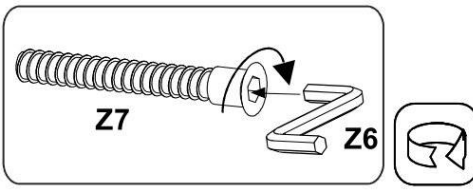
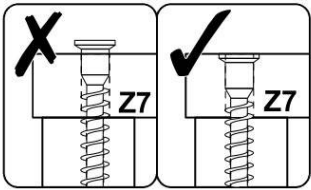
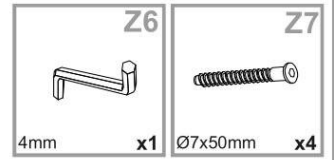
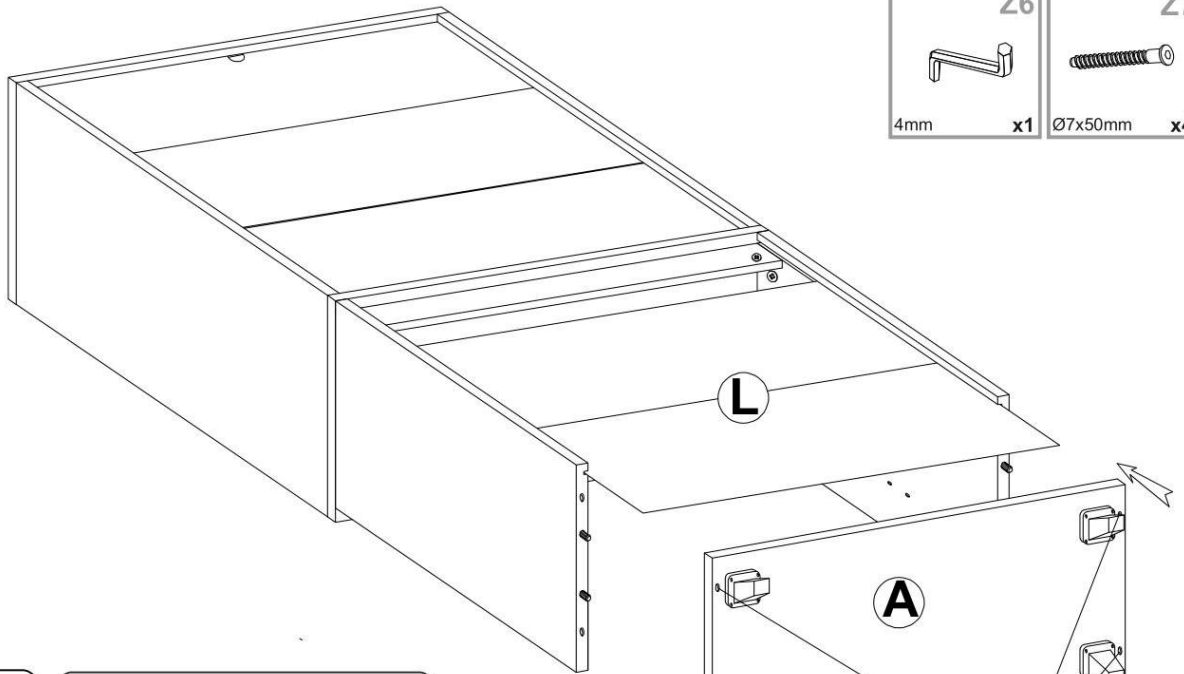



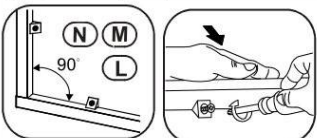
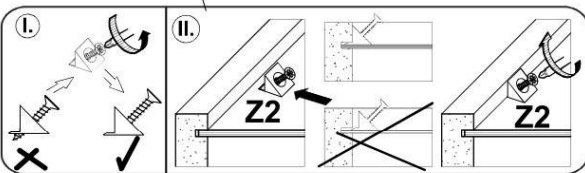
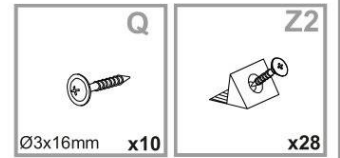
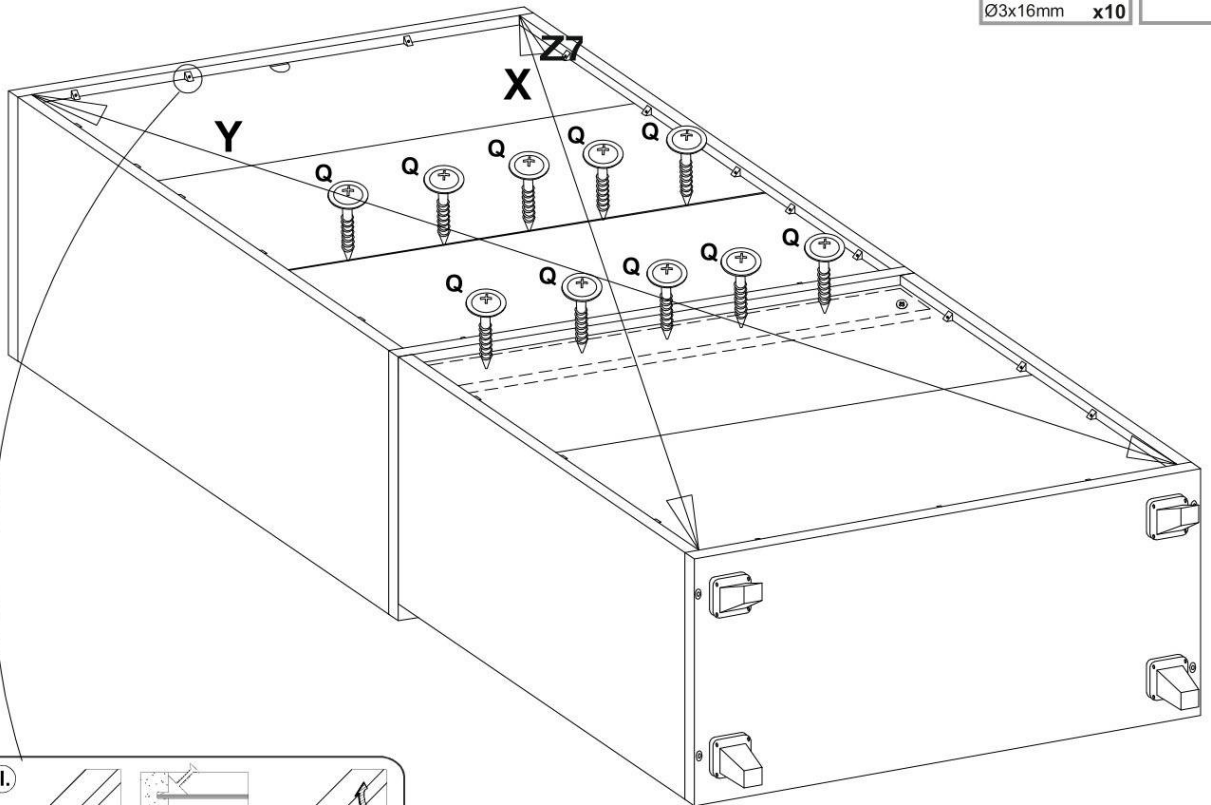

9

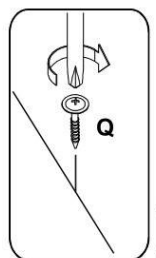

X = Y



10

 Z9 x8	 R Ø4x40mm x1	 S Ø4x16mm x2	 T x1	 U Ø8x40mm x1
---	--	---	--	---

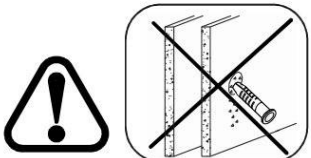
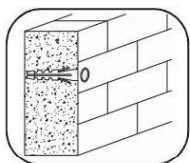
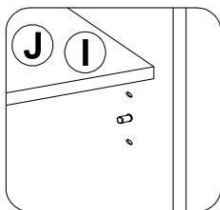
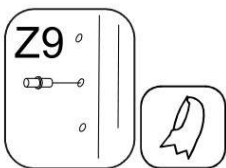
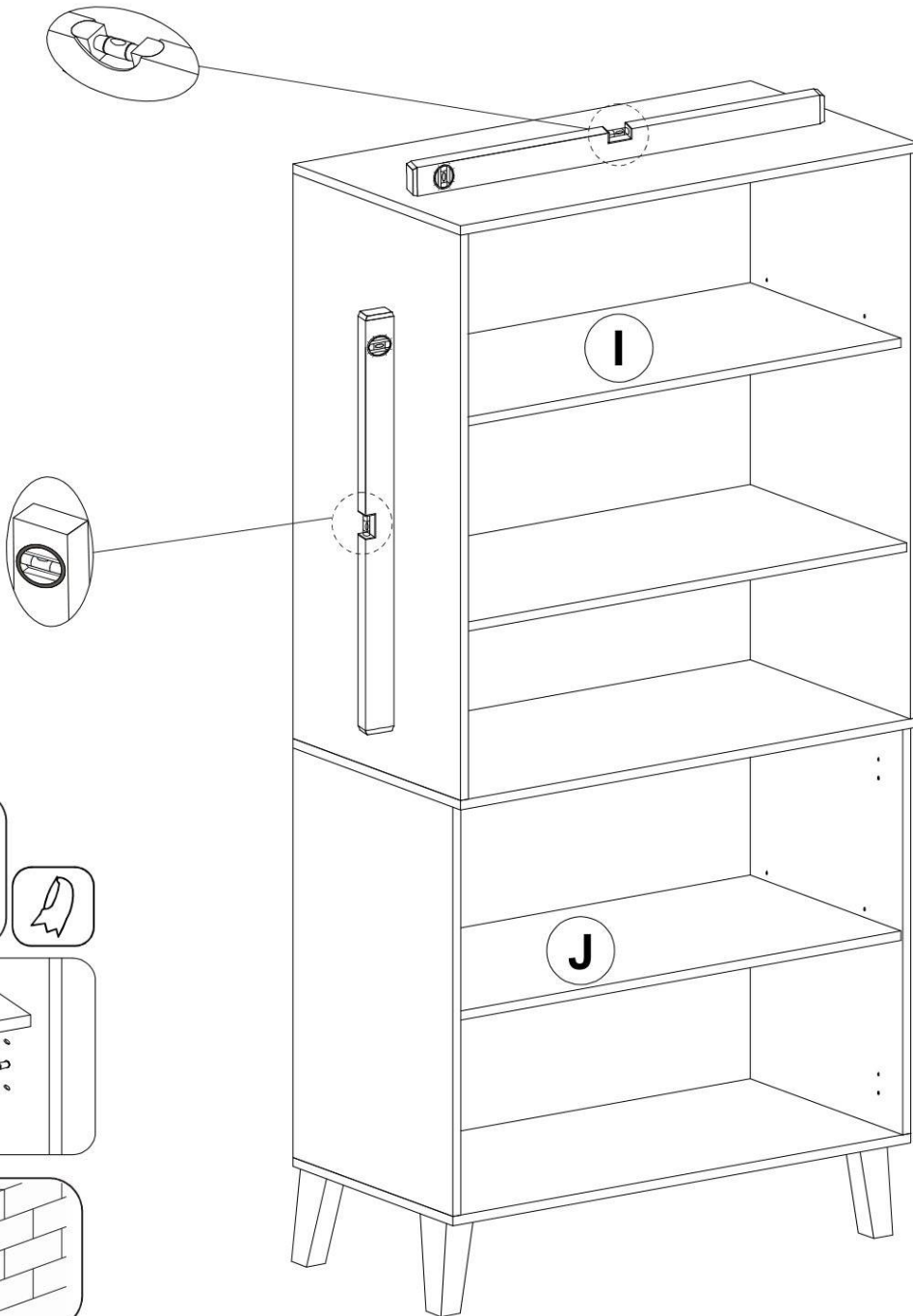
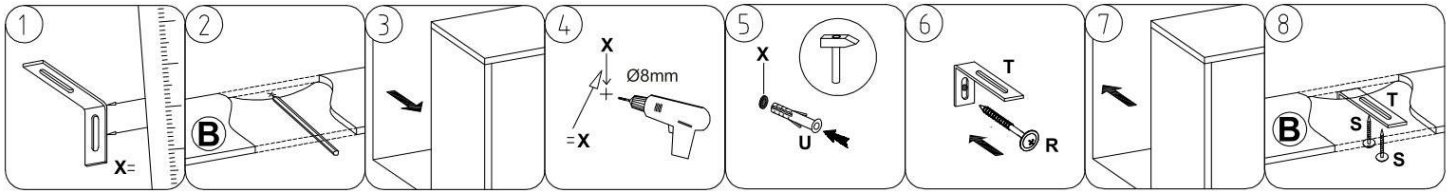

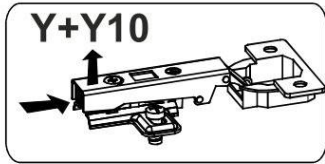

11

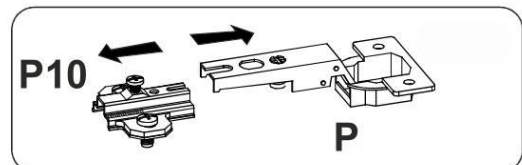
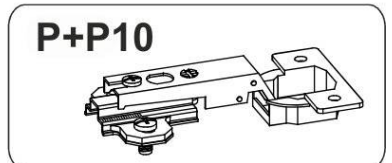
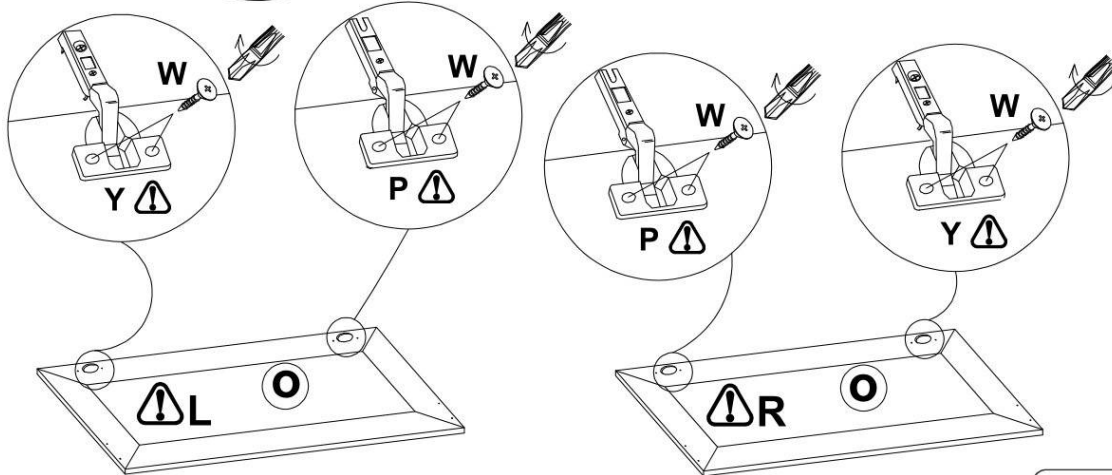
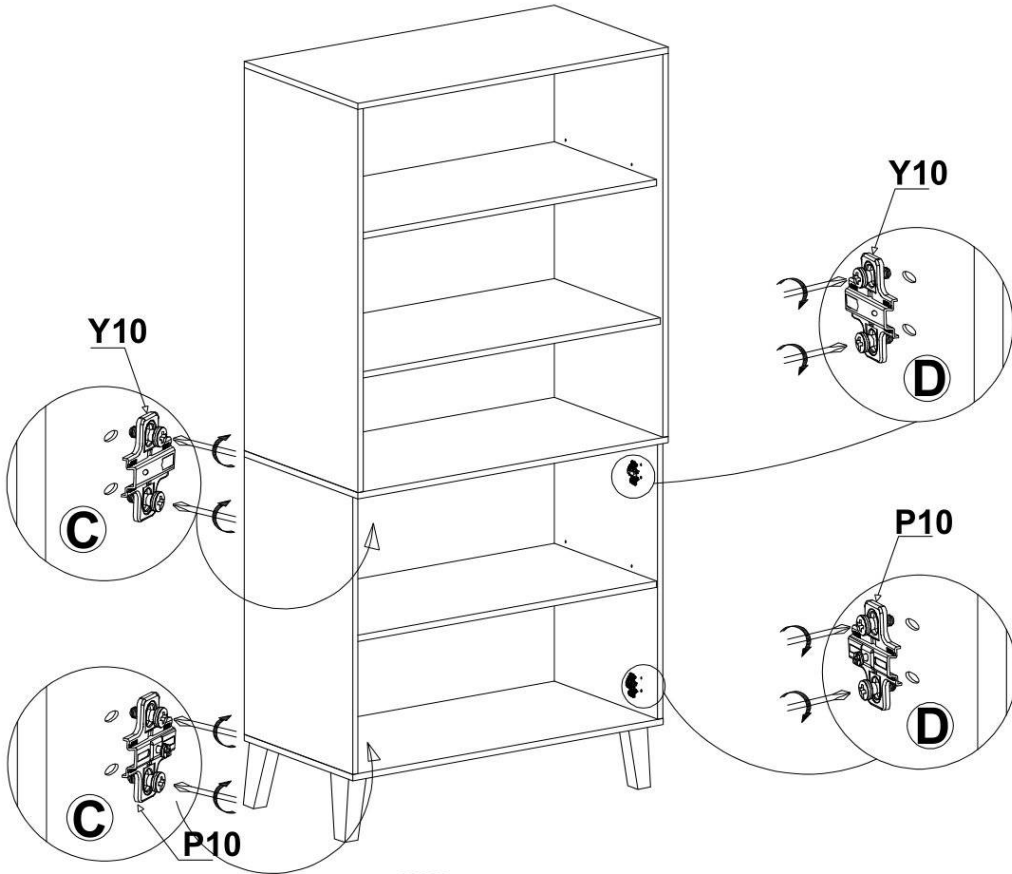
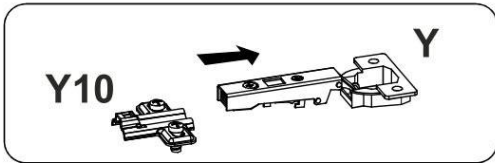

W Ø3,5x16mm x8	P+P10 KR-0 x2	Y+Y10 KR-0 x2
------------------------------	-----------------------------	-----------------------------



12

 Z8 Ø18mm x12	 Q Ø3x16mm x4	 Z1 L-116mm x2
--	--	---

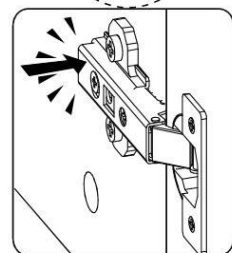
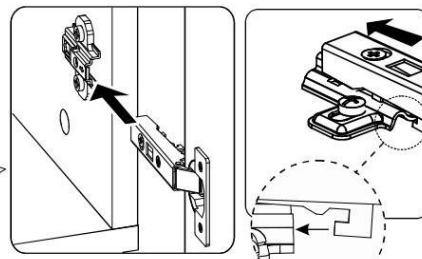
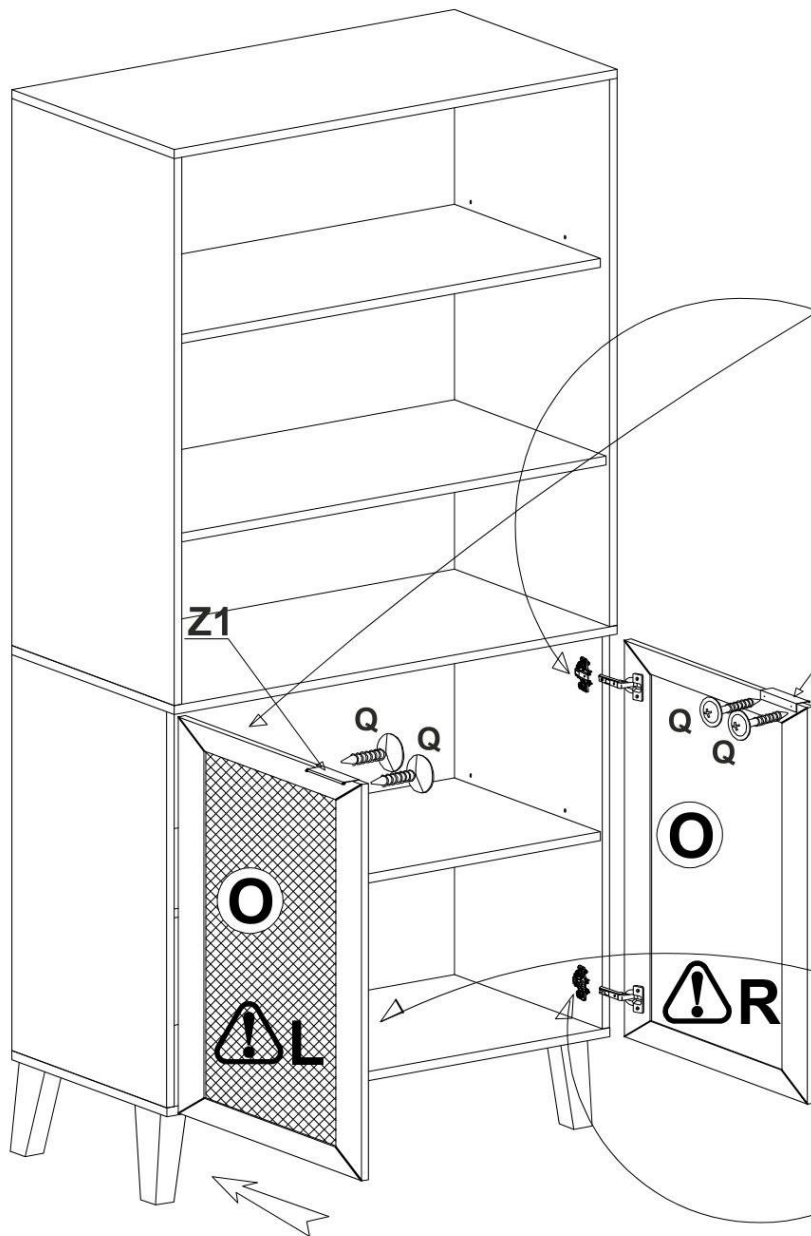

Y+Y10



P+P10

