

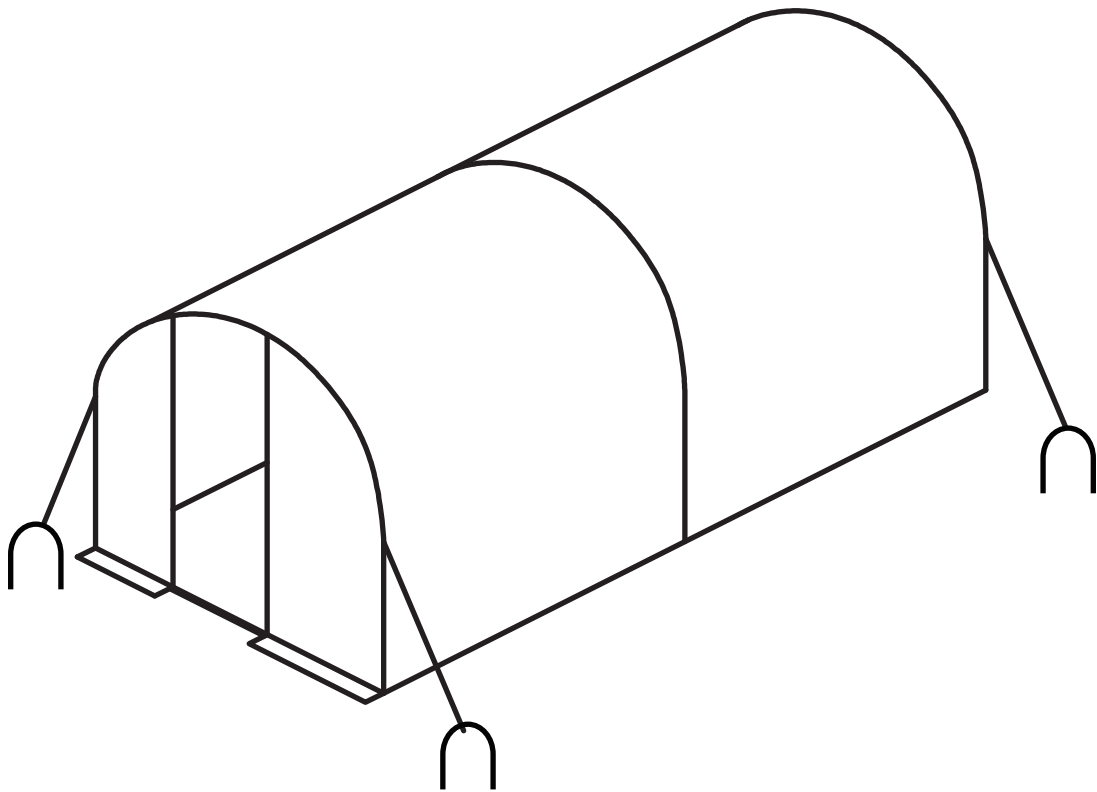

Instrucaction Manual

Tunnel-greenhouse



4mx2.5mx2m (Ref:SER-5)

4mx2.5mx2m (Ref:SER-5)

IMPORTANT

-Please read the entire assembly manual before using the product and then keep it for future reference

PRODUCT SAFETY

-Children should not play with the greenhouse

-Cleaning and maintenance should not be carried out by unsupervised children

-Do not use the greenhouse for purposes other than those for which it was designed

WARNING
-Bags can be dangerous. To avoid the risk of suffocation, keep packaging away from children and babies.

WARNING

-Bags can be dangerous. To avoid the risk of suffocation, keep packaging away from children and babies.



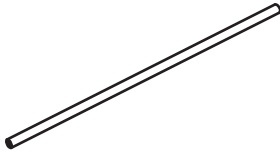
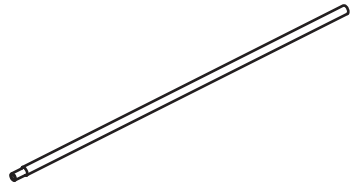
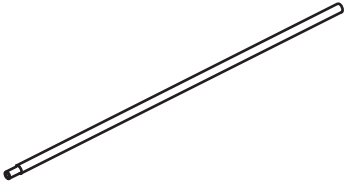
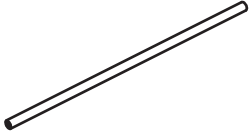
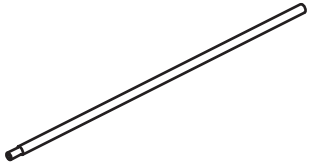
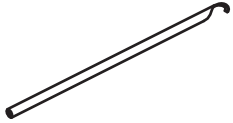
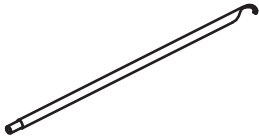
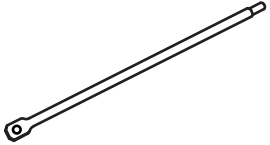

PART LIST

1.	2.	3.
		
QTY: 20 pcs	QTY: 5 pcs	QTY: 15 pcs
3-1.	4.	5.
		
QTY: 2 pcs	QTY: 5 pcs	QTY: 5 pcs
6.	7.	8.
		
QTY: 2 pcs	QTY: 2 pcs	QTY: 2 pcs

PART LIST

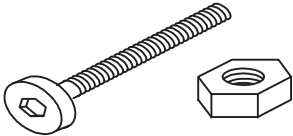
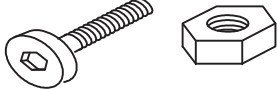
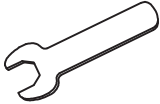
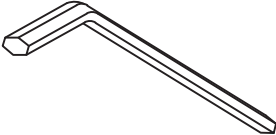
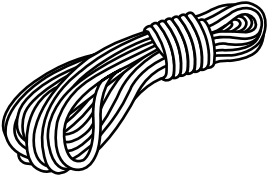
9.		
		
QTY: 2 pcs		

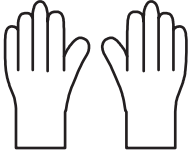
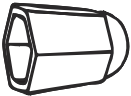
HARDWARE LIST

A.	B.	C.
		
QTY: 25 pcs	QTY: 16 pcs	QTY: 1 pcs
D.	E.	F.
		
QTY: 1 pcs	QTY: 4 pcs	QTY: 4 pcs
G.	H.	I.
		
QTY: 2 pcs	QTY: 27 pcs	QTY: 10 pcs

ASSEMBLY INSTRUCTIONS

STEP 1

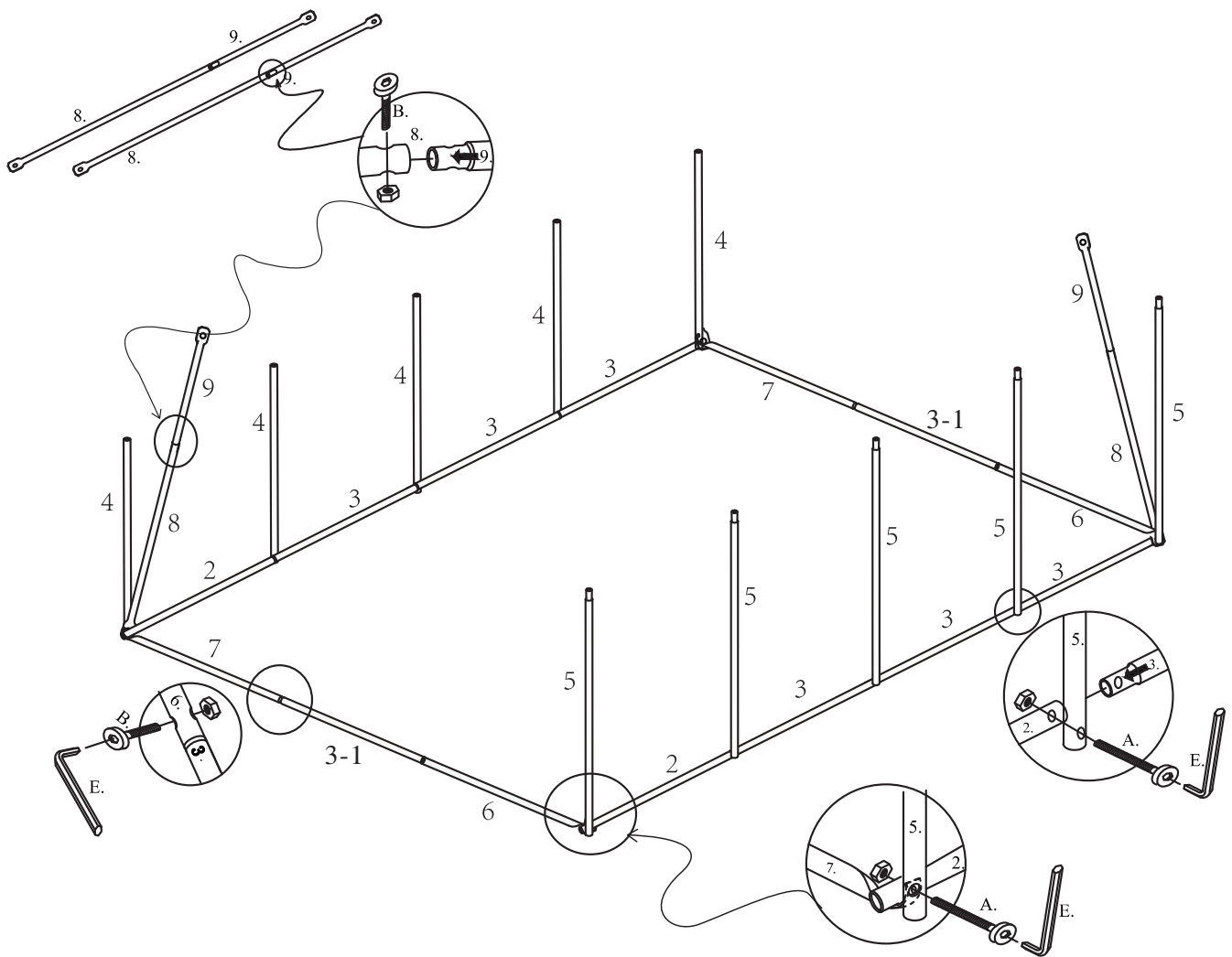

ASSEMBLY INSTRUCTIONS

STEP 2

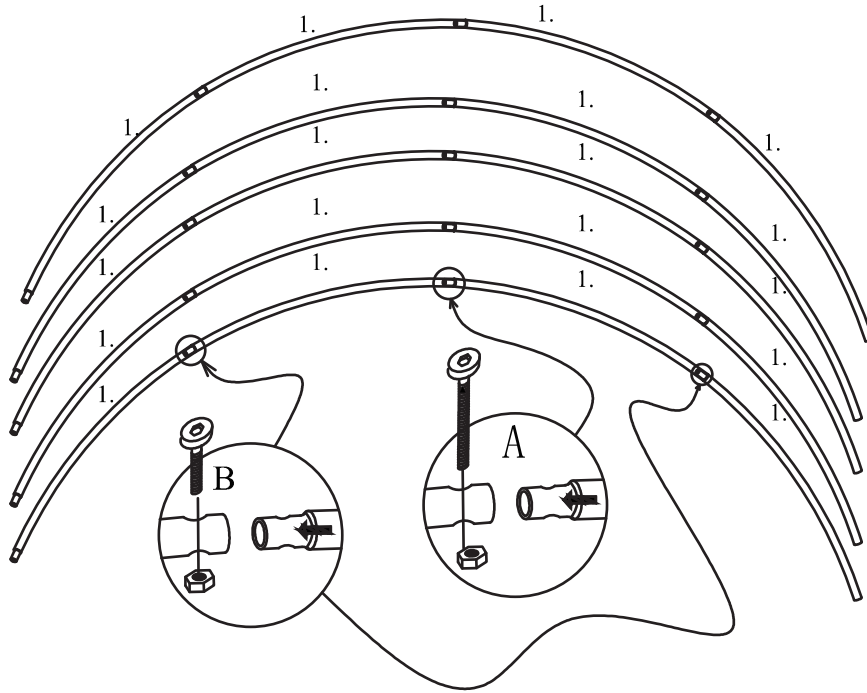

STEP 3

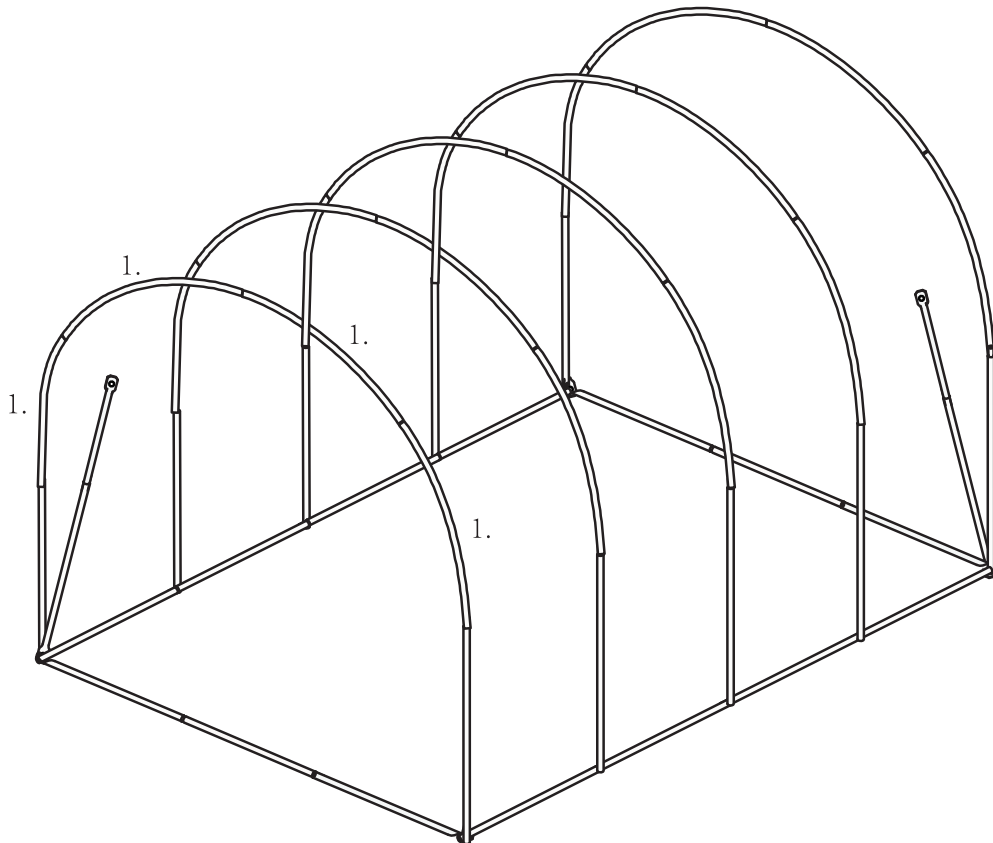

ASSEMBLY INSTRUCTIONS

STEP 4

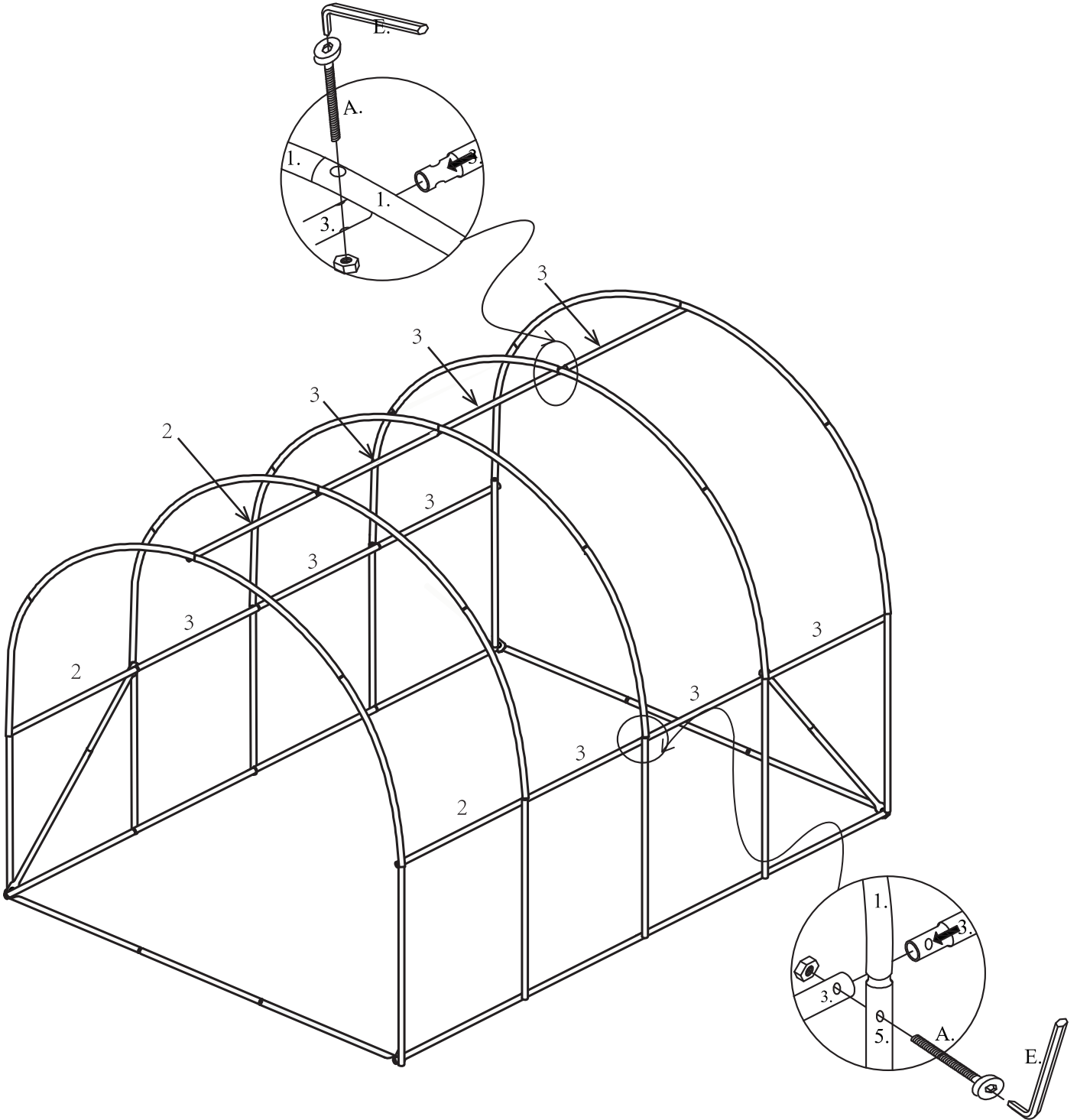

ASSEMBLY INSTRUCTIONS

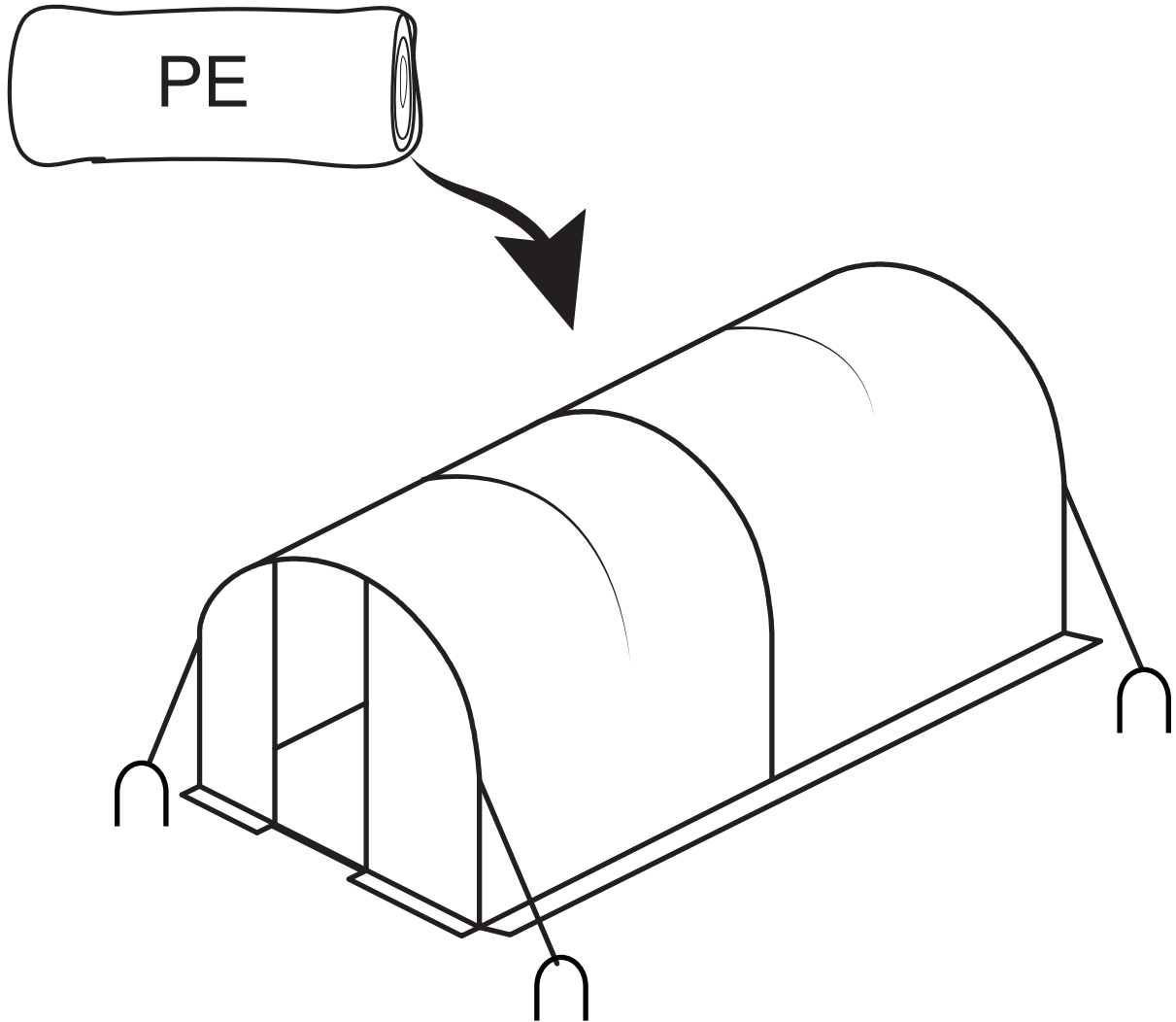

END