

INSTRUKCJA MONTAŻU  
FITTING-UP INSTRUCTION  
ІНСТРУКЦІЯ МОНТАЖУ  
ИНСТРУКЦИЯ СБОРКИ

MONTÁŽNY NÁVOD  
INSTRUCTIONS POUR LE MONTAGE  
INSTRUCCIONES DE MONTAJE  
SZERELÉSI ÚTMUTATÓ  
UPUTE ZA SASTAVLJANJE

Do montažu potrebne są:  
You need for fitting-up:  
Для монтажу потрібно:  
Для сборки нужны:

Pour le montage il faut:  
Para realizar el montaje es necesario:  
K montá i potrebujete:  
A szereléshez szükséges:  
Za sastavljanje su potrebne:

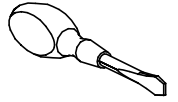
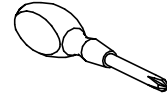
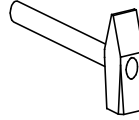
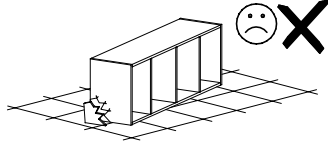
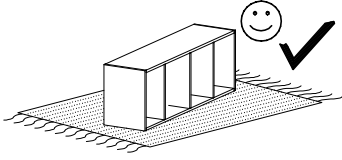

# TULIA

hanging shelf / półka wisząca

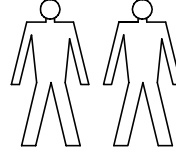

1	1398	184	16	1
2	1400	116	16	1
3	183	98	16	1
4	183	98	16	1

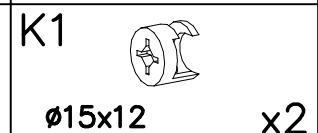
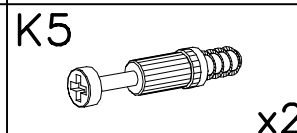
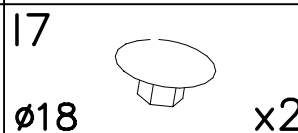
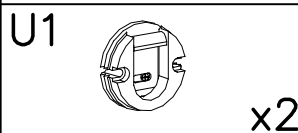
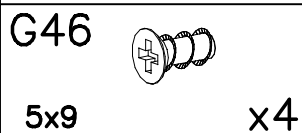
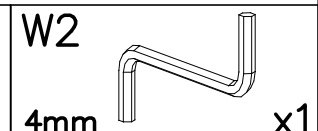
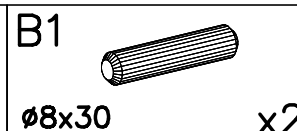
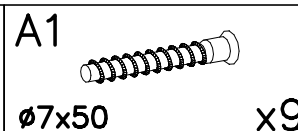
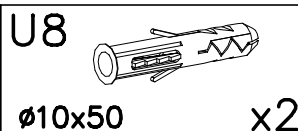
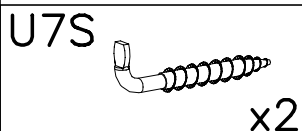
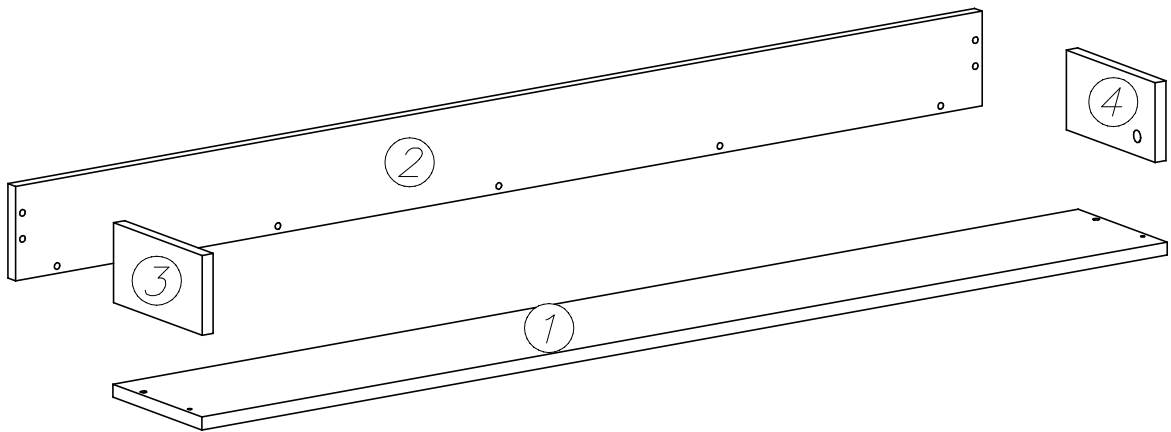
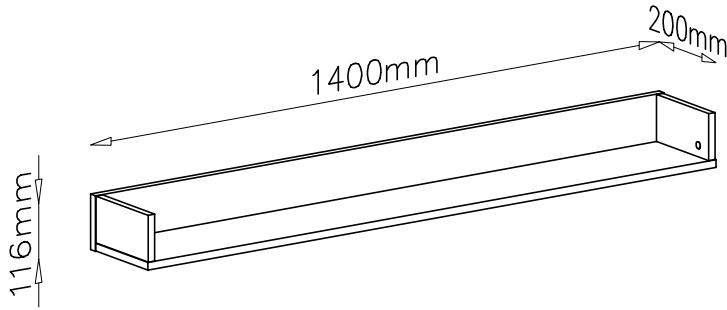

PL– Proszę nie montować mebla, jeżeli jego elementy są uszkodzone.

Przed zmontowaniem poszczególne elementy mebla należy dokładnie obejrzeć. W przypadku uszkodzeń, należy je zgłosić wraz z dokumentacją zdjęciową, celem rozpatrzenia reklamacji i podjęcia właściwych działań.

EN– Please do not assemble the furniture if its parts are damaged.

Before assembling, individual elements of the furniture should be carefully inspected.

In case of visible damage, it should be reported along with photographic documentation, to analyse the complaint and take appropriate action.

FR– Si vous constatez que les pièces sont endommagées, veuillez ne pas monter le meuble.

Avant le montage, les éléments individuels du mobilier doivent être soigneusement inspectés. En cas d'un endommagement, ils doivent être signalés avec la documentation photographique afin d'examiner la réclamation et de prendre les mesures appropriées.

DE– Bitte montieren Sie die Möbel nicht, wenn ihre Teile beschädigt sind.

Vor dem Zusammenbau sollten einzelne Elemente der Möbel sorgfältig geprüft werden.

Im Schadensfall sollten sie zusammen mit der Foto Dokumentation gemeldet werden, um die Beschwerde zu prüfen und geeignete Maßnahmen zu ergreifen.

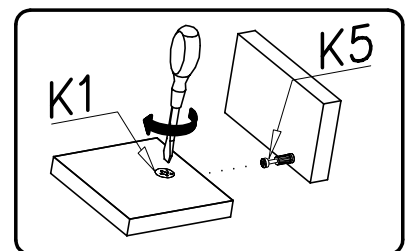
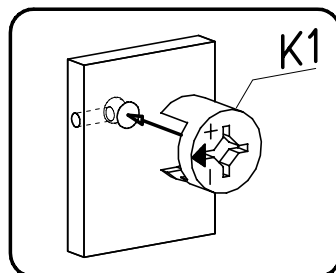
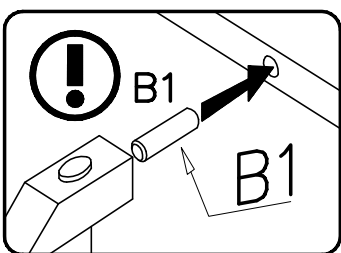
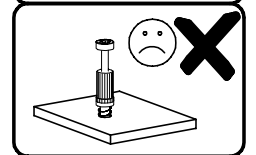
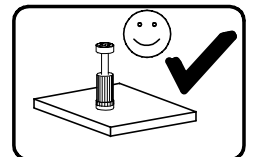
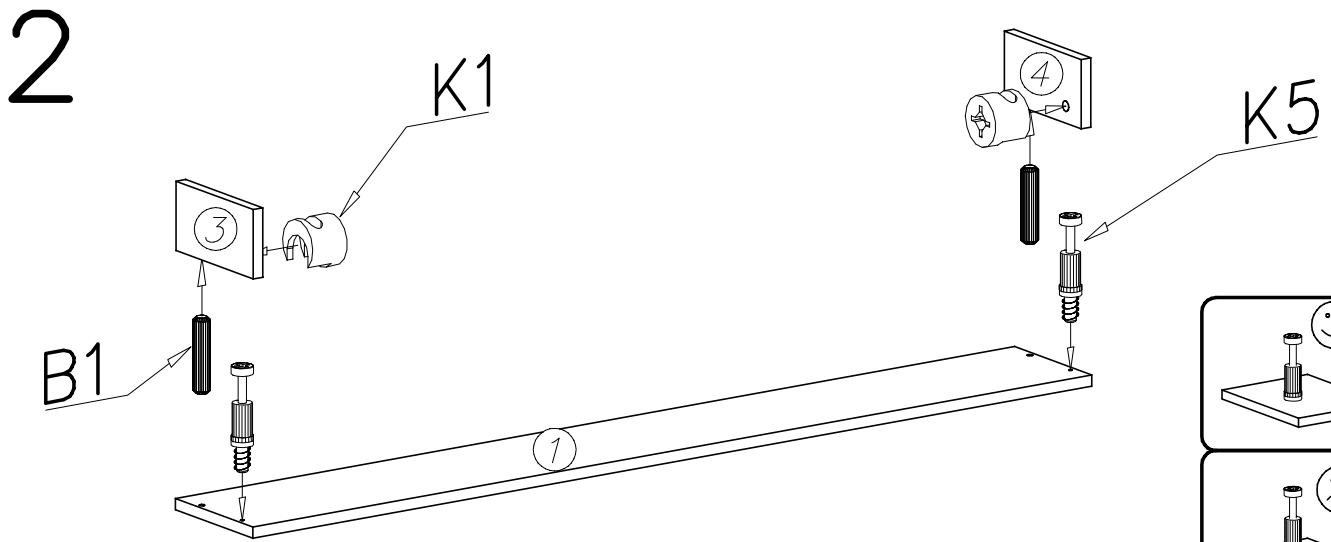
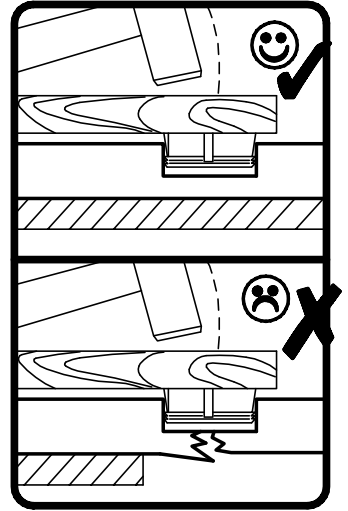
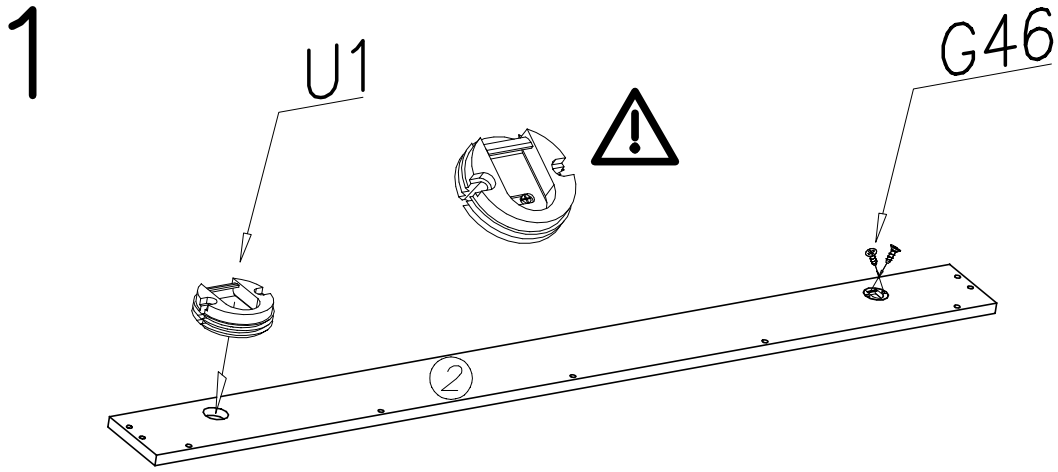
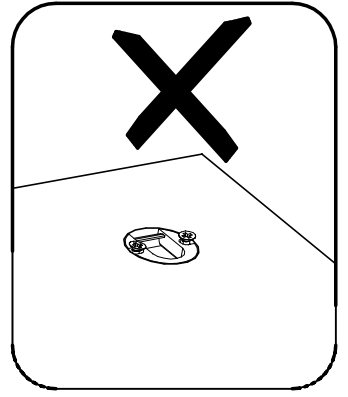
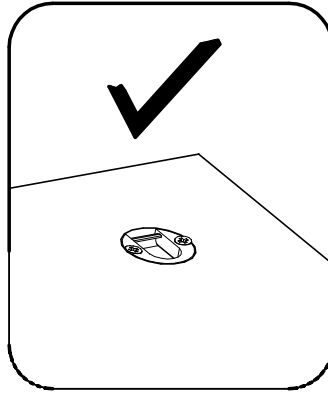
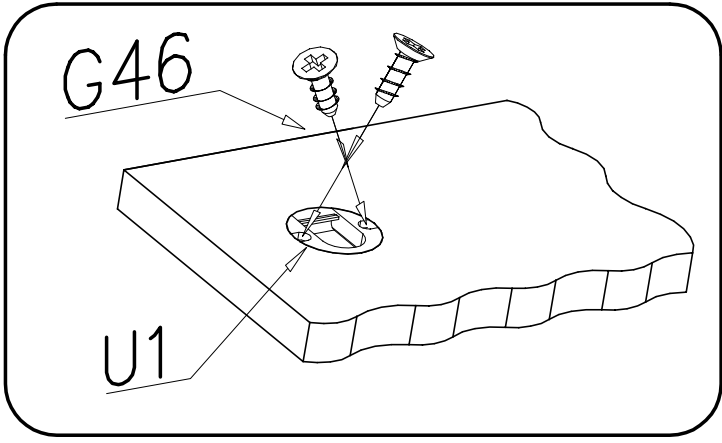

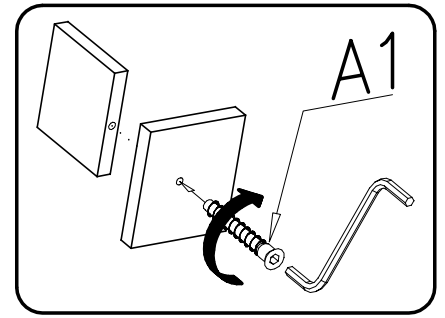
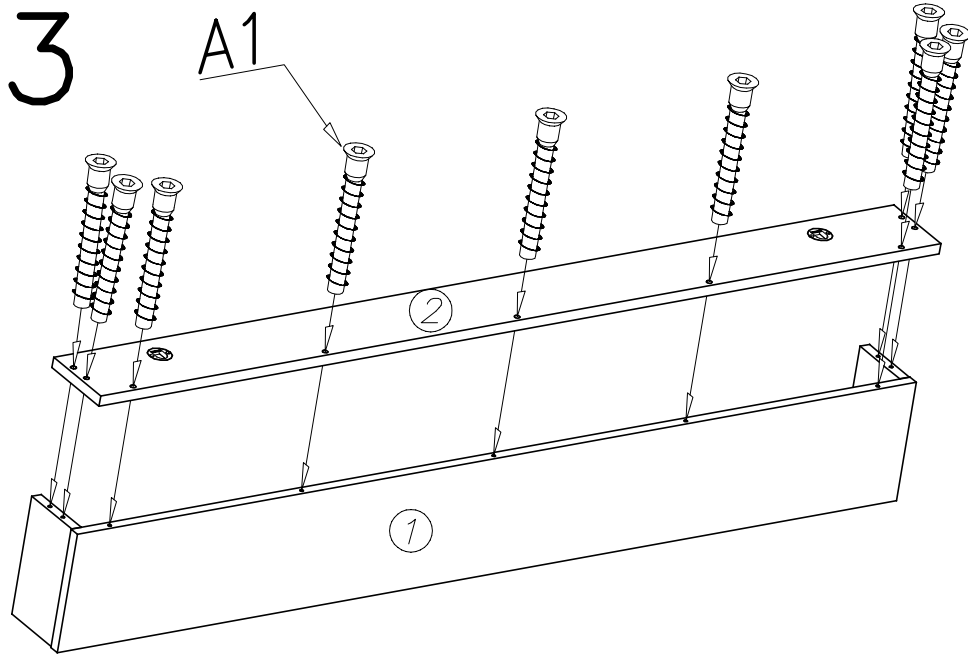

# 1

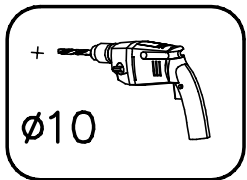

# 2

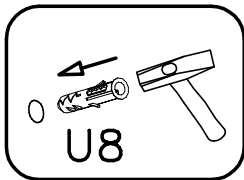

# 3

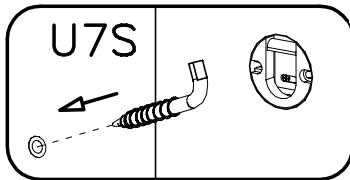

# 4

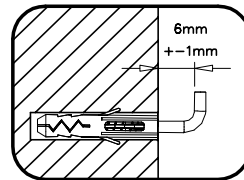

# 5

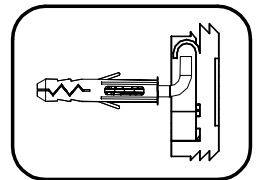

# 4

