

# INSTRUKCJA MONTAŻU

MDS  
[www.szafkinabuty.pl](http://www.szafkinabuty.pl)

## MAROKO

	x1		
--	----	--	--

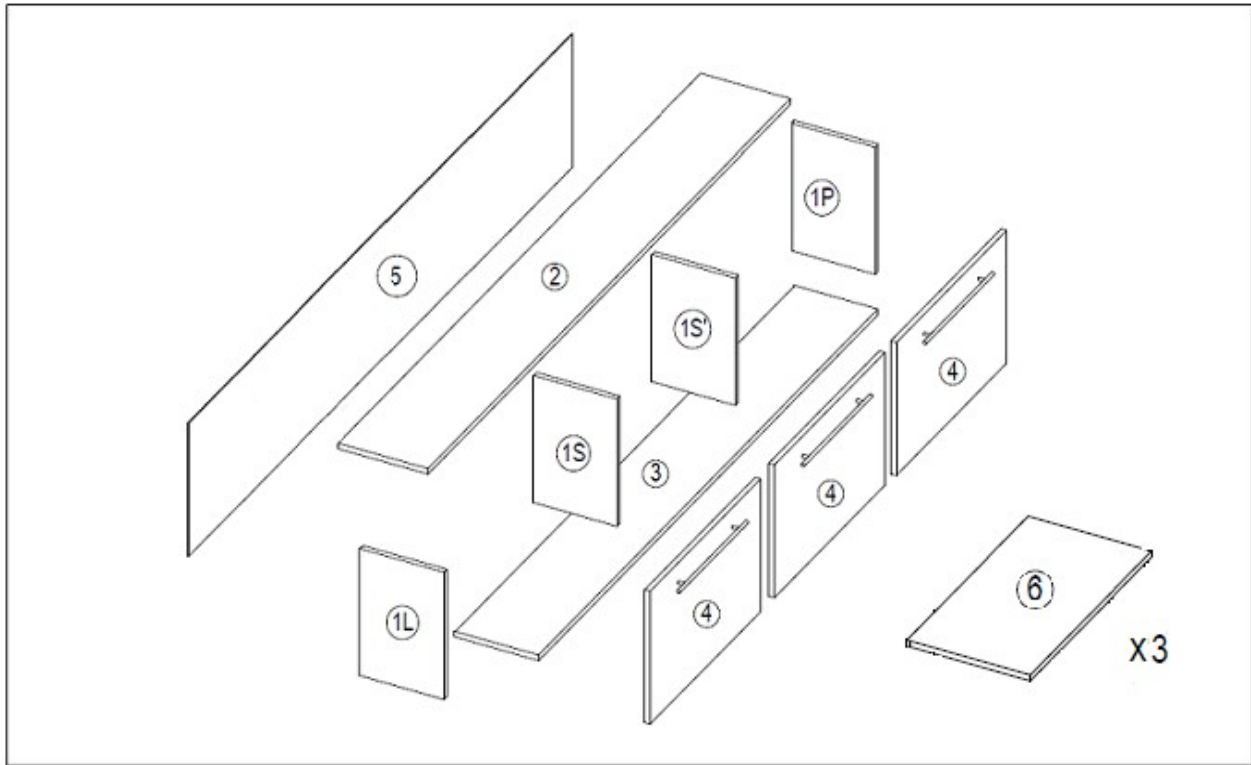

A x16 	B x16 	C x16 	D x12 	E x6 	F x12 	G x6 
H x36 	I x3 	J x12 	K x6 	L x6 	M x3 	

# 1

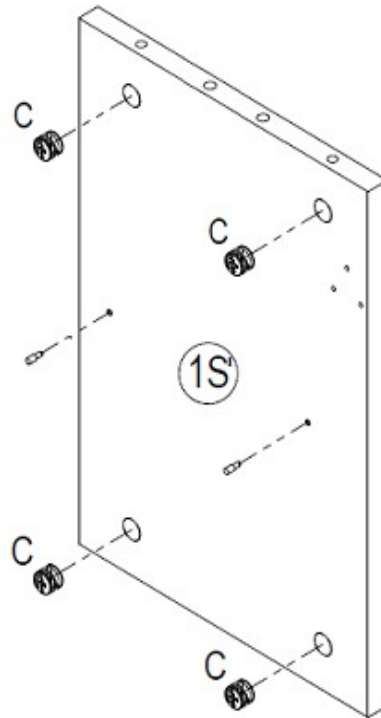
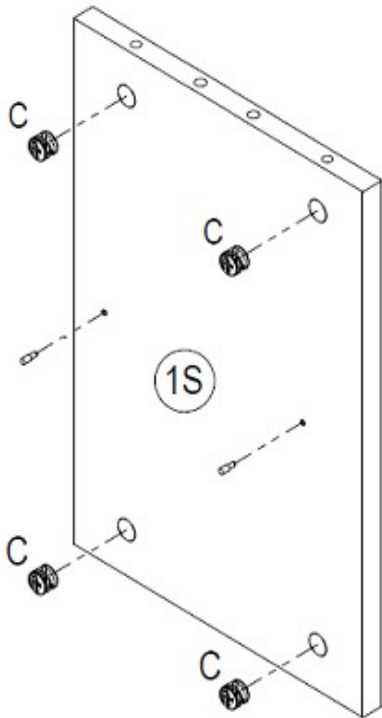
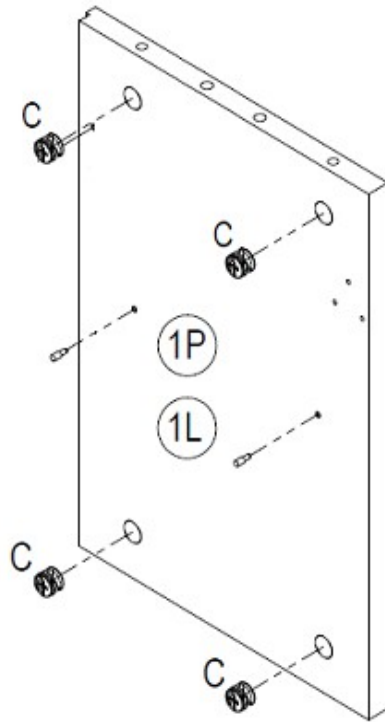
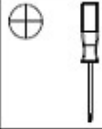

# 2



A



B



E



x6

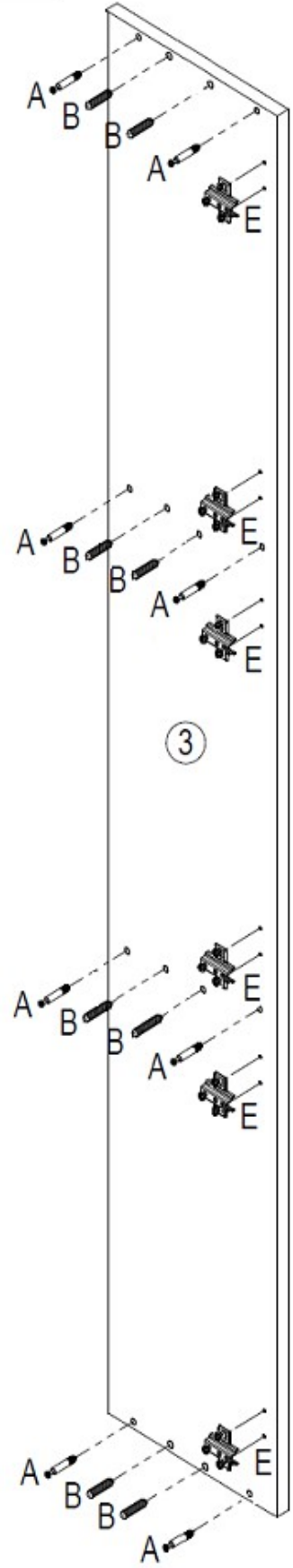
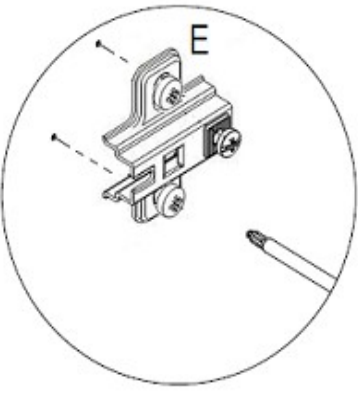
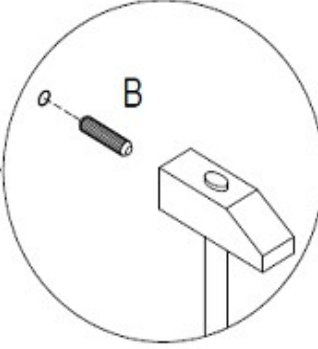
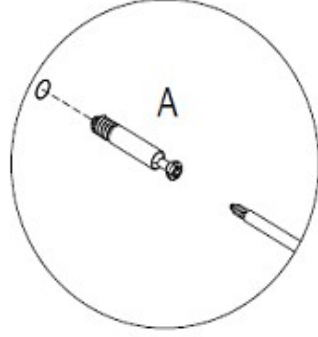
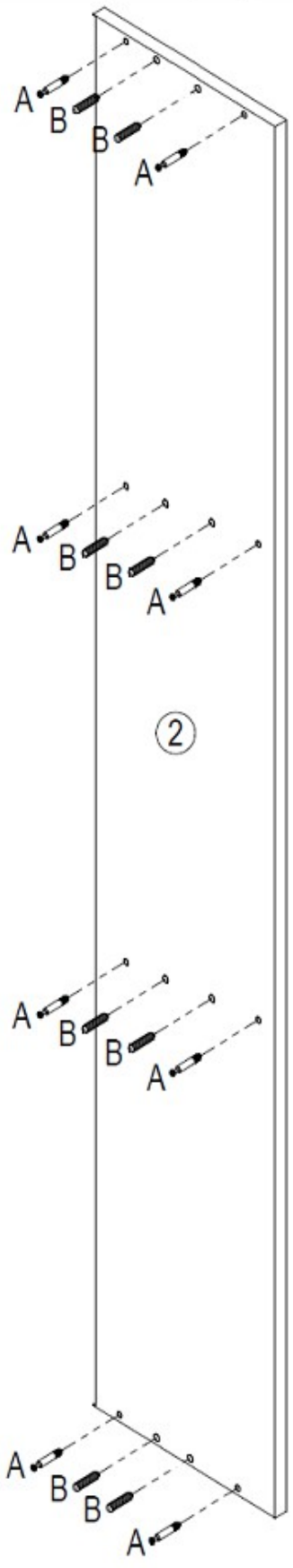

**3**

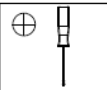

MONTAŽ KORPUSU

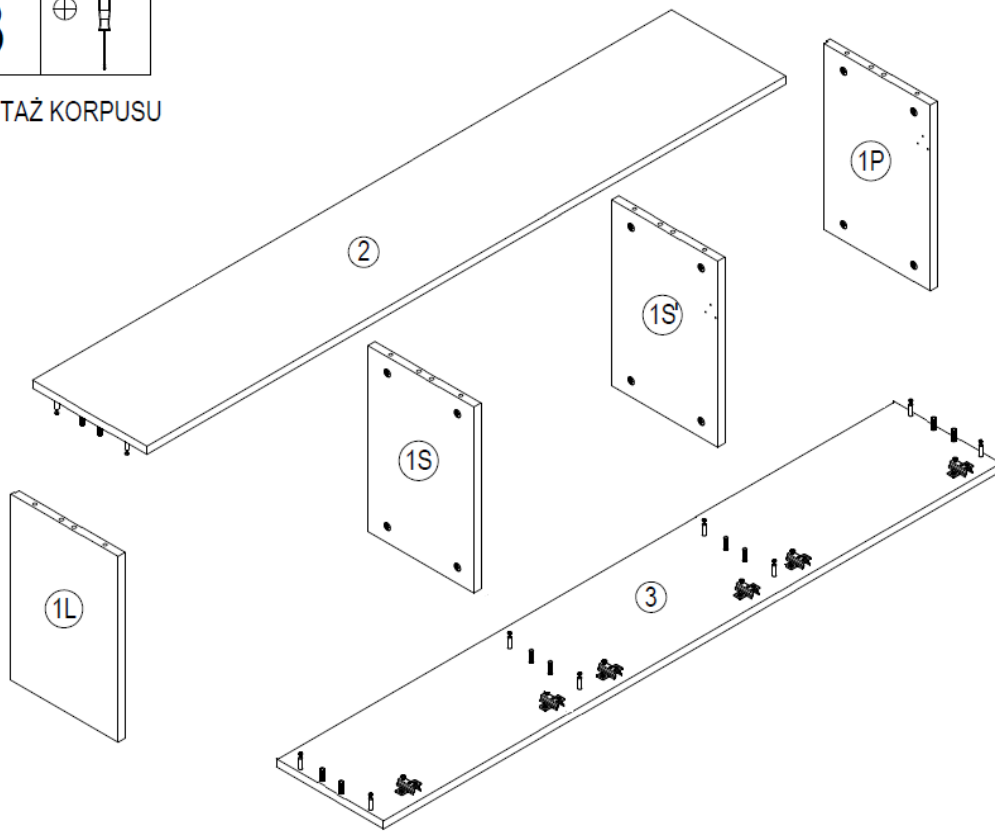

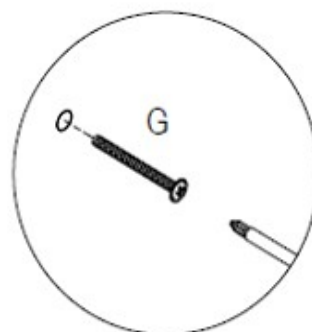
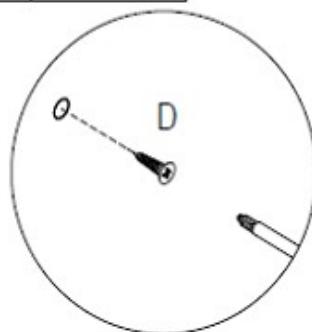
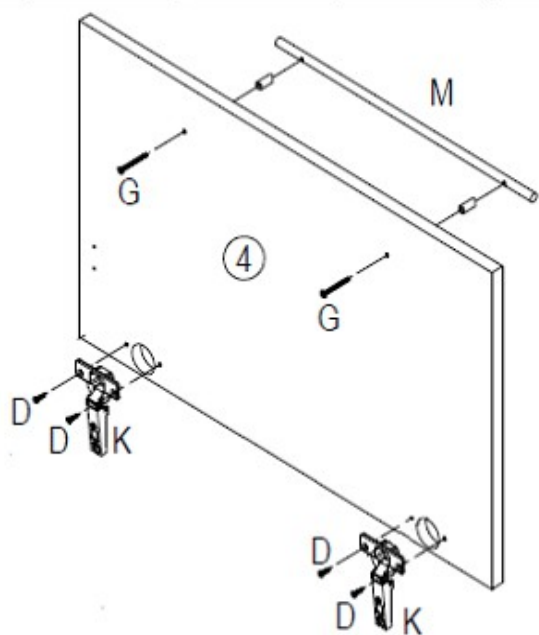
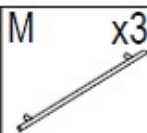
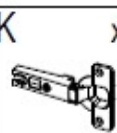
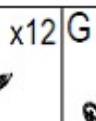
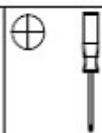
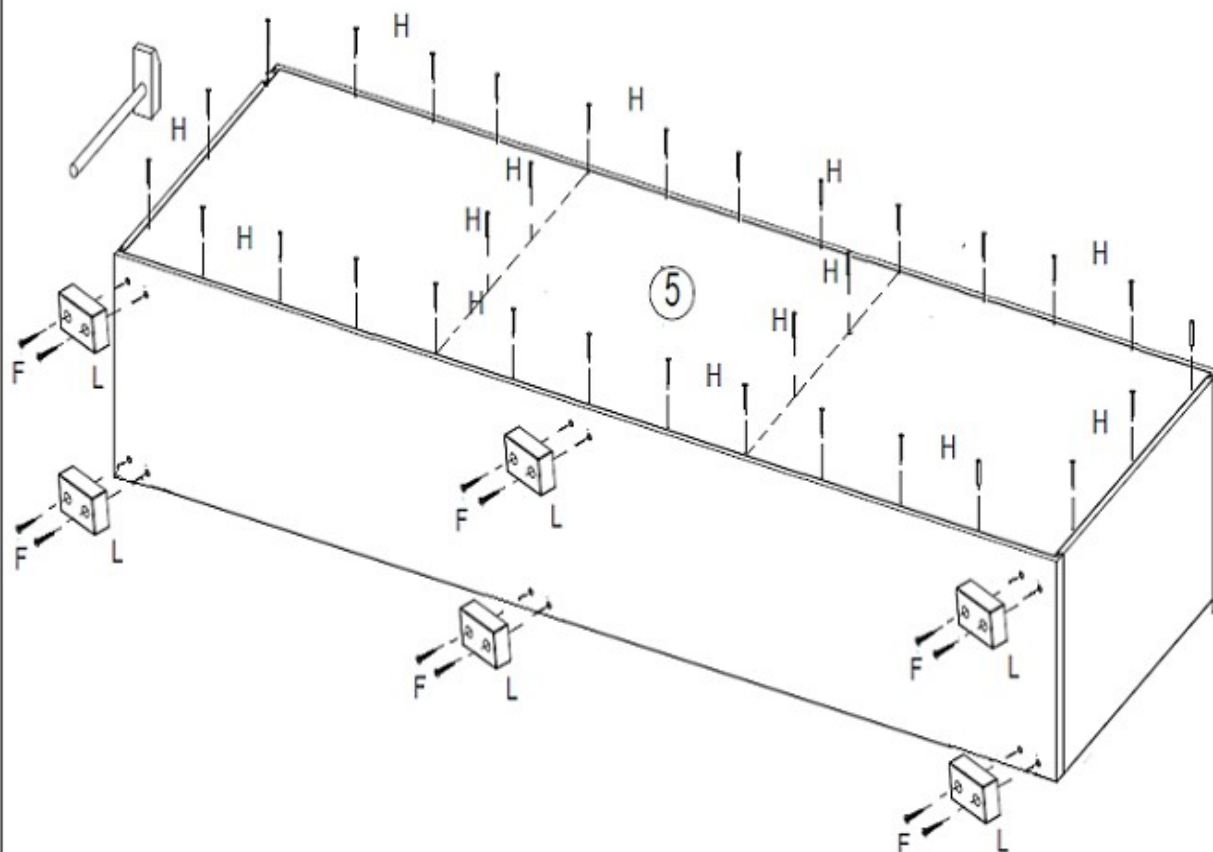
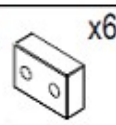
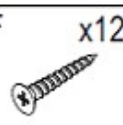
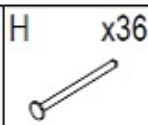
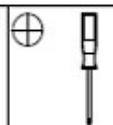
**4****5**

6

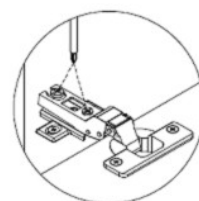
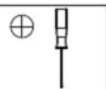

montaż i regulacja zawiasu

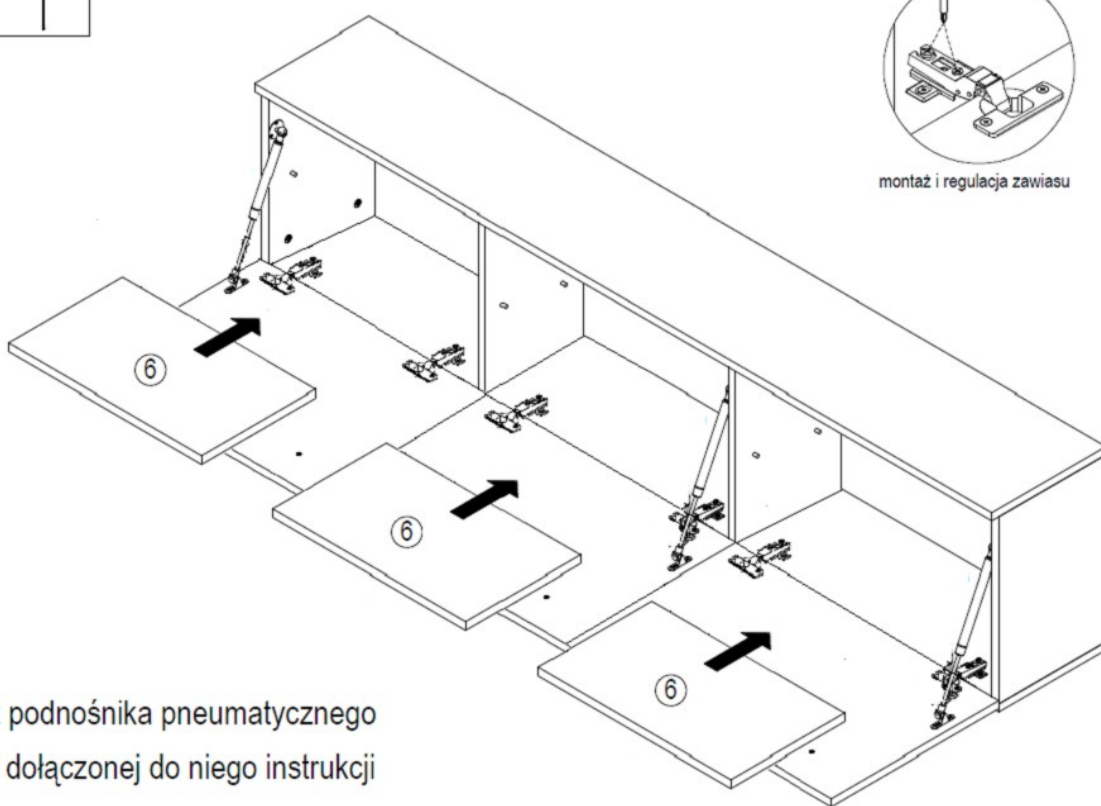

montaż podnośnika pneumatycznego  
według dołączonej do niego instrukcji