

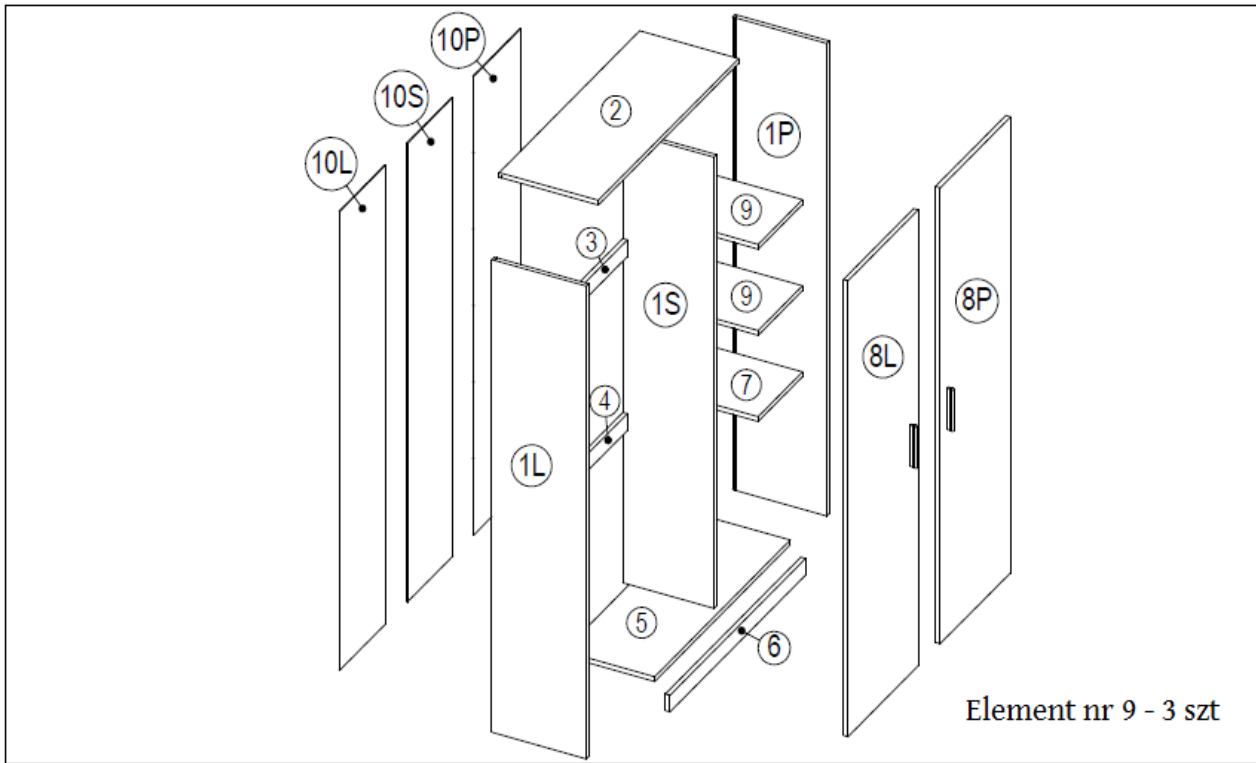

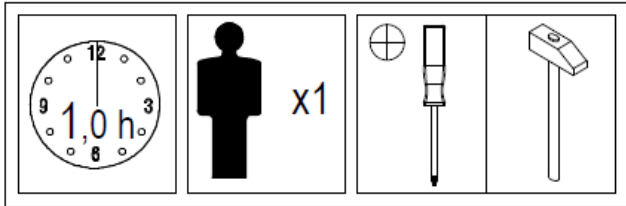



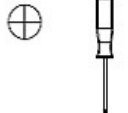

# INSTRUKCJA MONTAŻU

[www.szafkinabuty.pl](http://www.szafkinabuty.pl)

## VERA 190



A x22	B x24	C x22	D x14	E x12	F x4	G x1
H x60	I x6	J x6	K x40	L x2	M x1	N x1
O x7	P x5	Q x6				

<b>1</b>			A x10 	B x9 	C x4 	E x12 	I x6 
	 K x20						

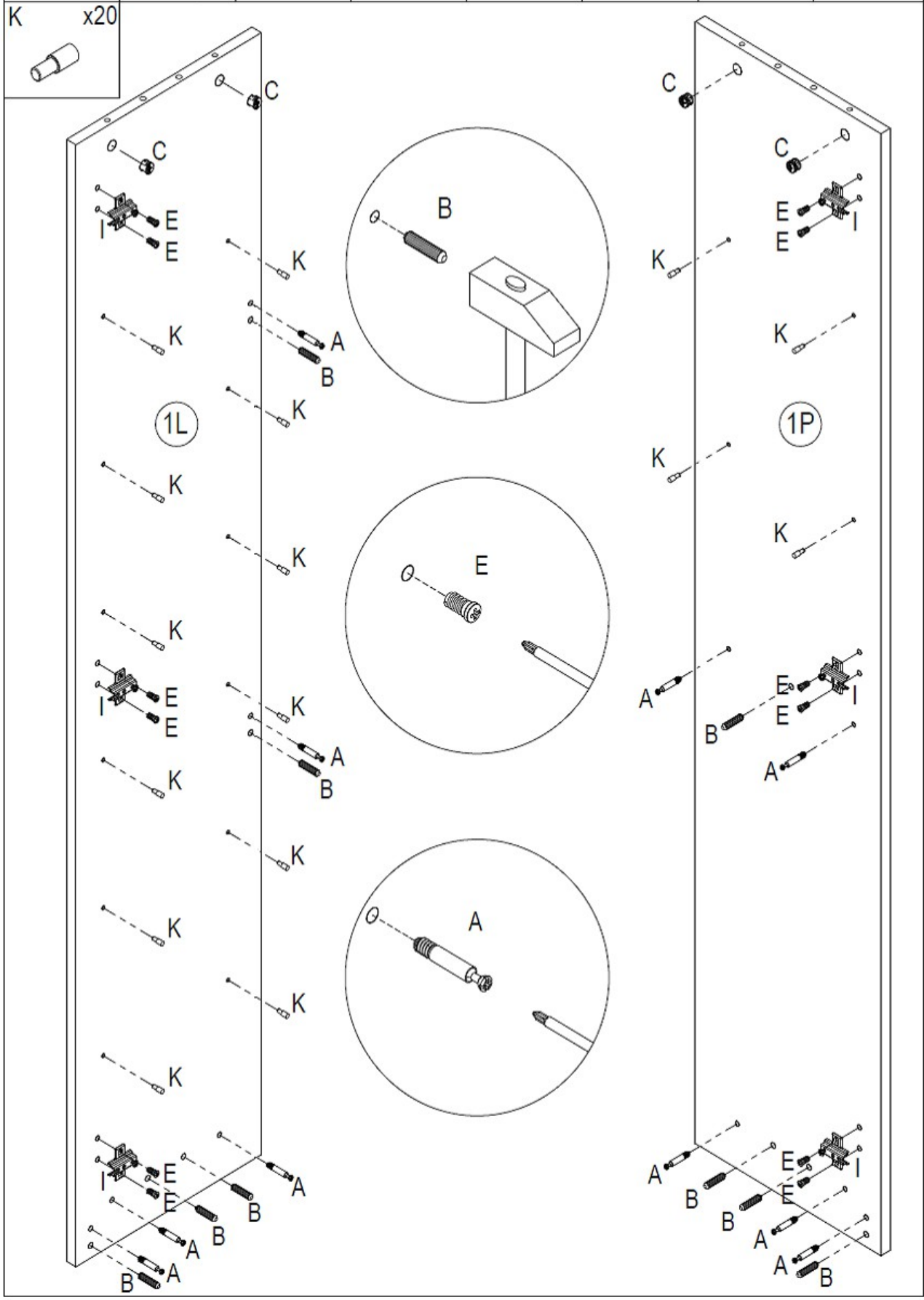

# 2

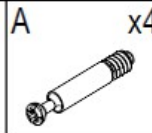

x4

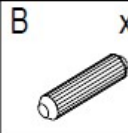

x3



x4

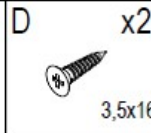

x2

3,5x16

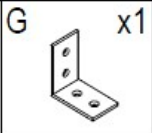

x1

K x20

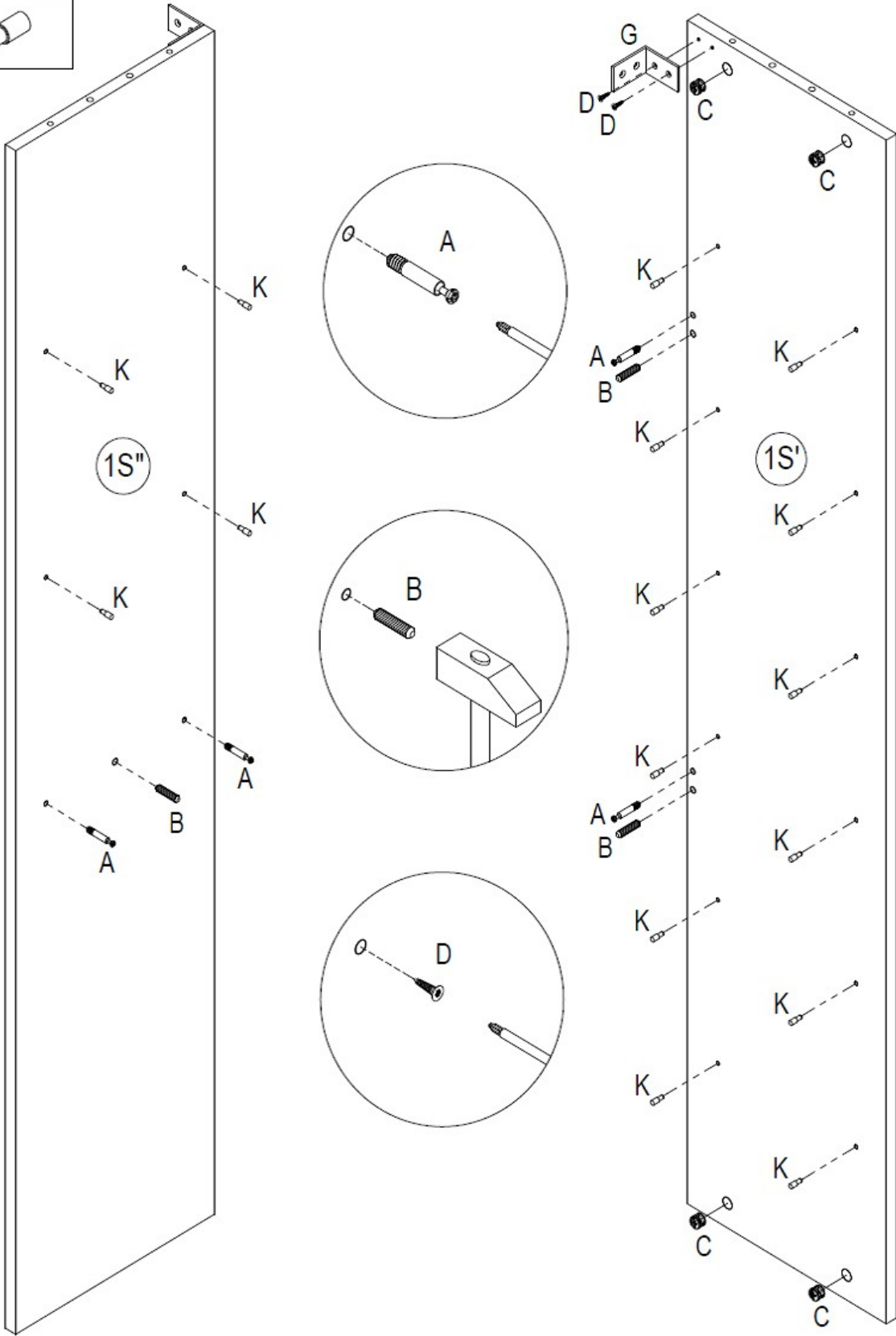

# 3

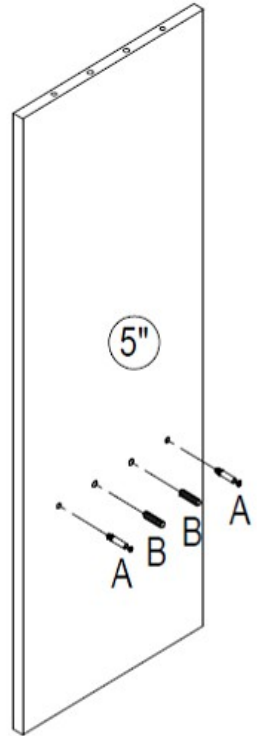
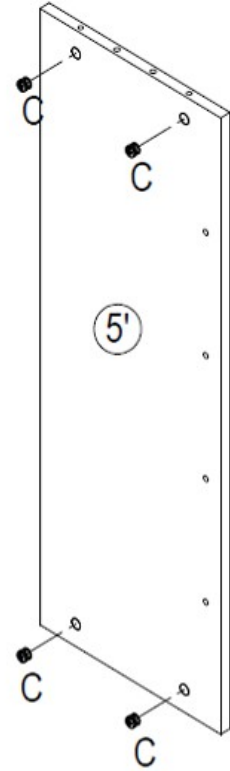
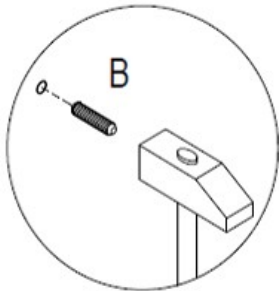
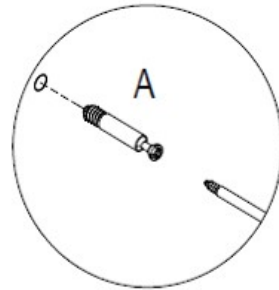
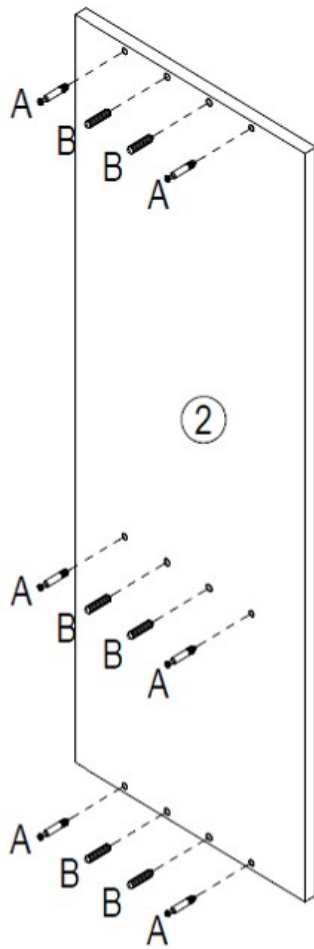
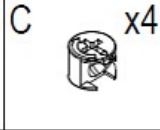
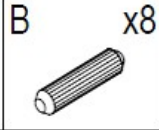
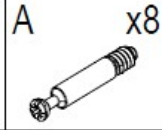
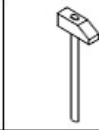
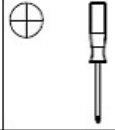

# 4

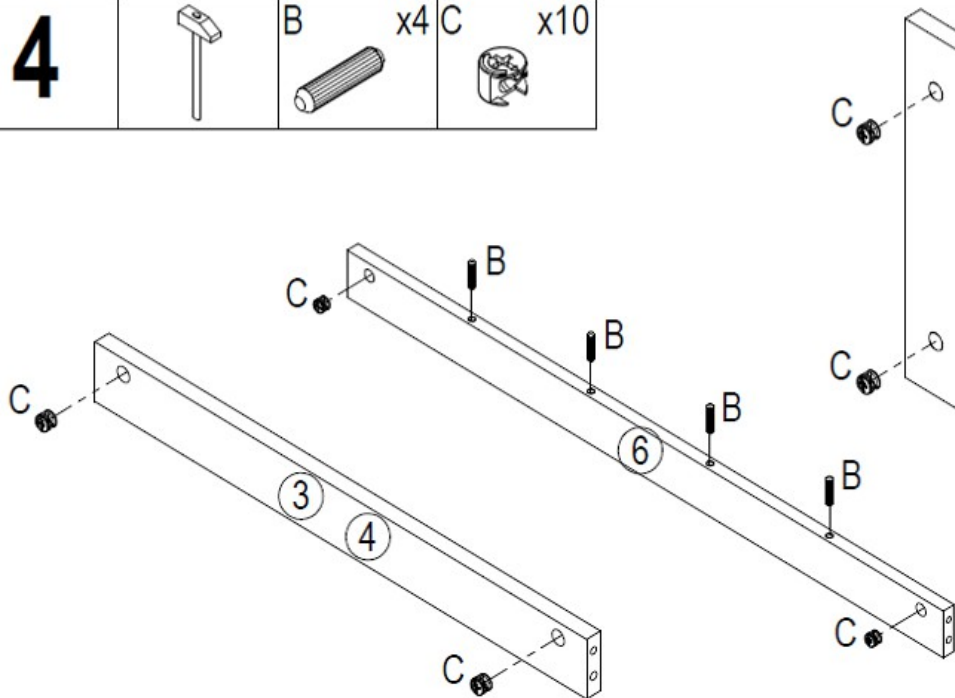
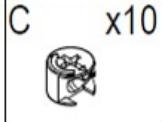
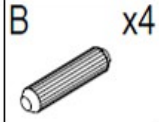

# 5

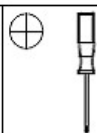

## MONTAŽ KORPUSU

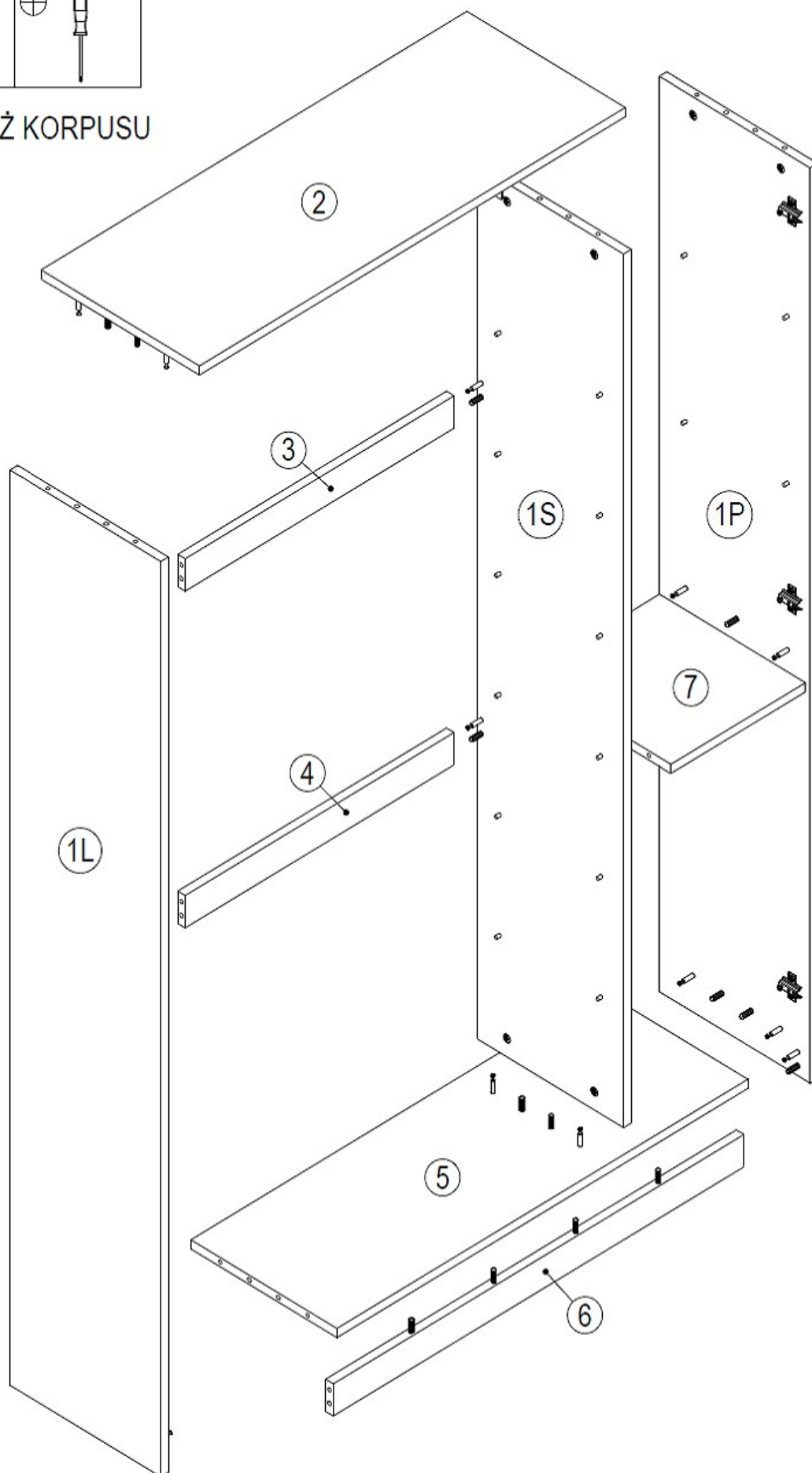

6

N x1

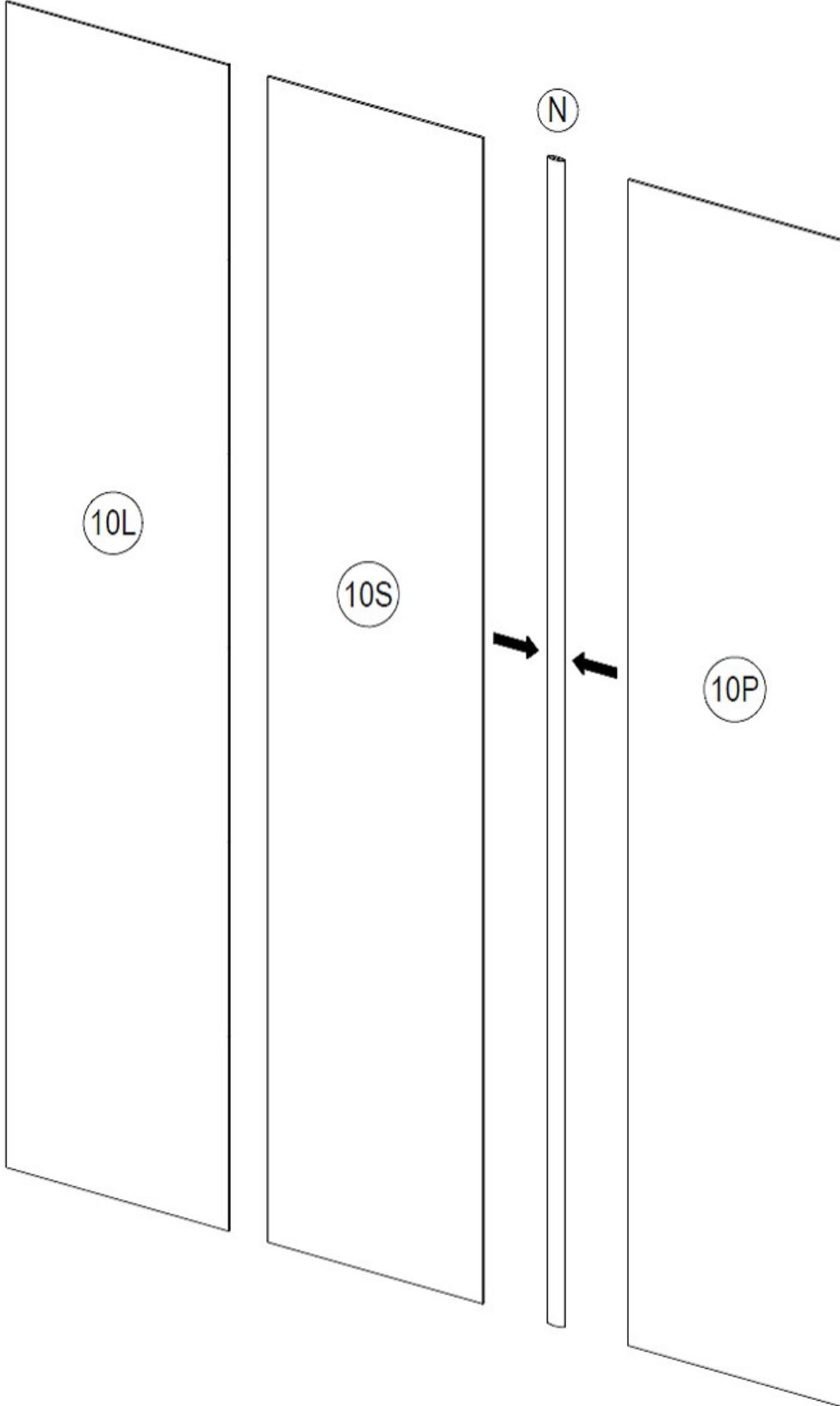

# 7

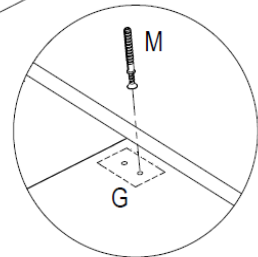
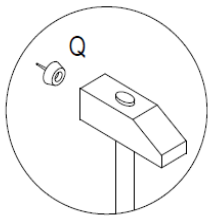
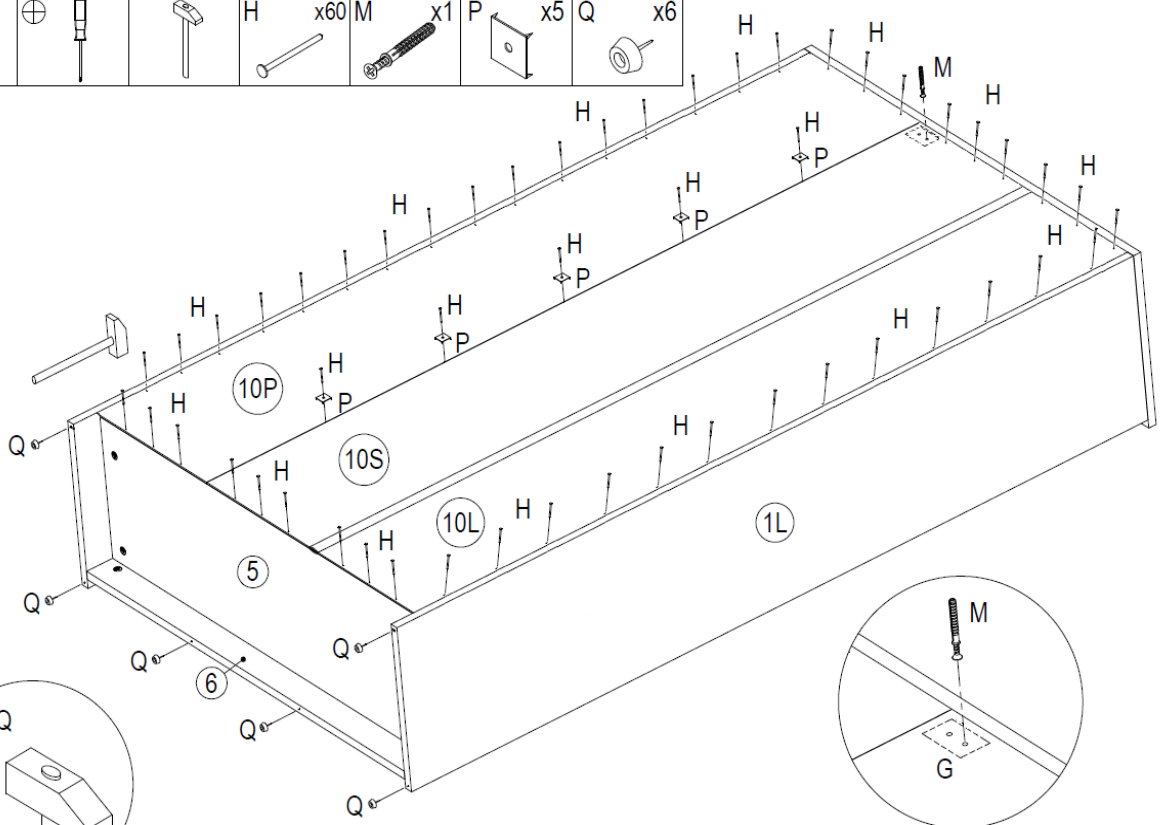
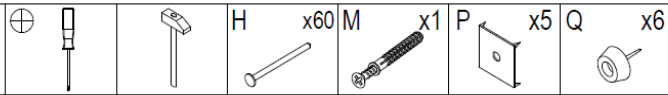

mocowanie szafy do ściany

8

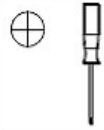

D x12



F x4



L x2



J x6

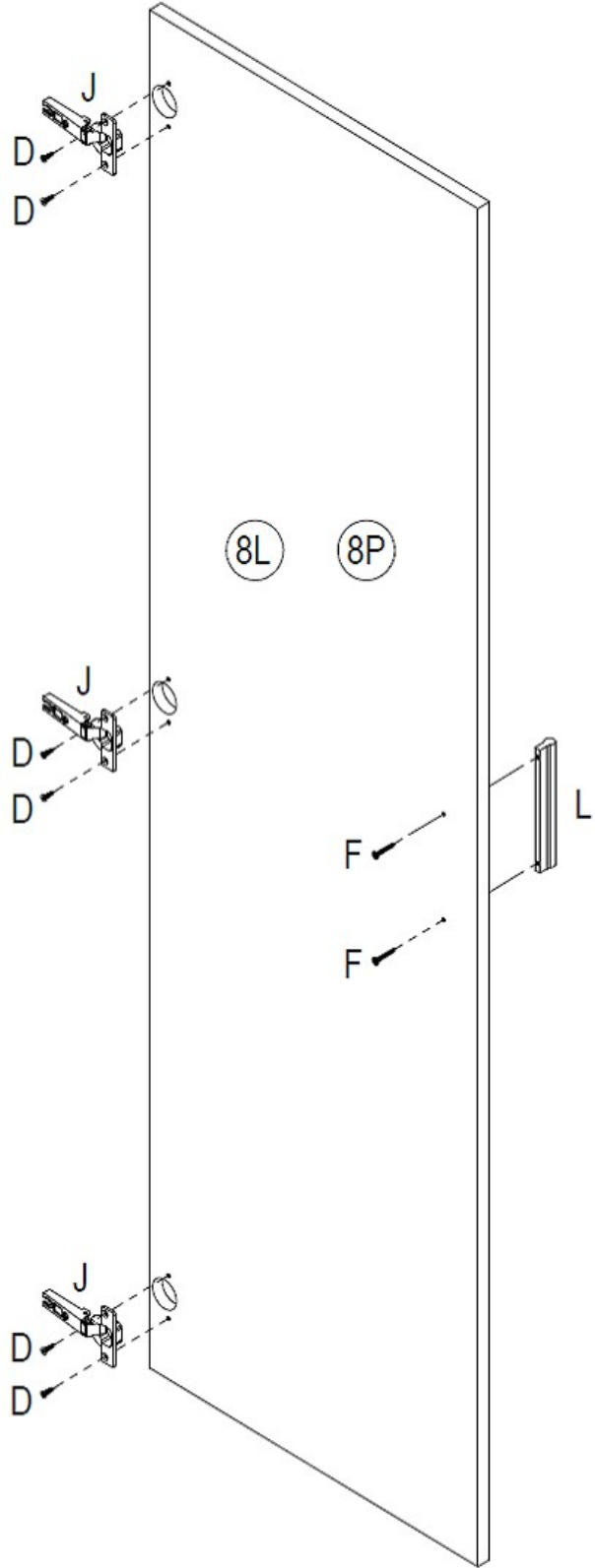
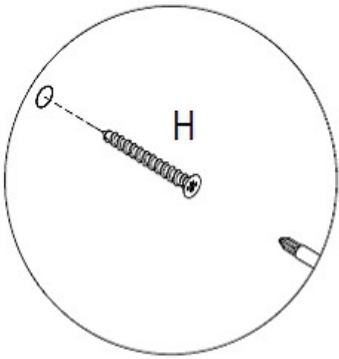
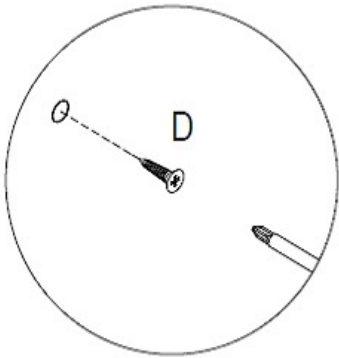
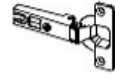

9

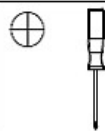

MONTAŻ DRZWI

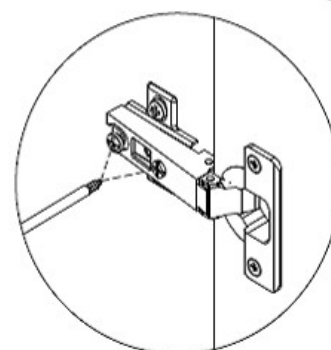
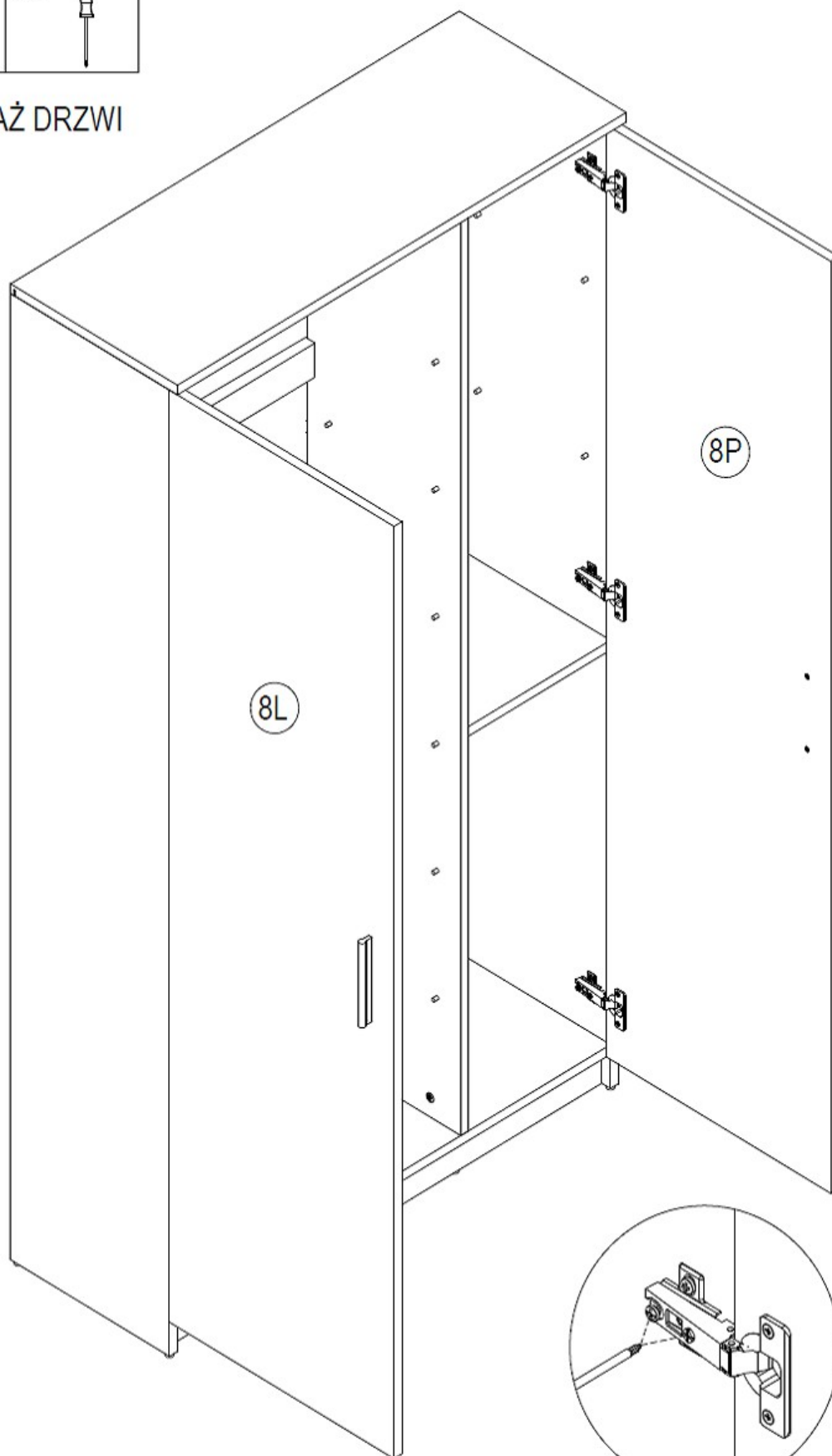

łączenie i regulacja zawiasu

10

