

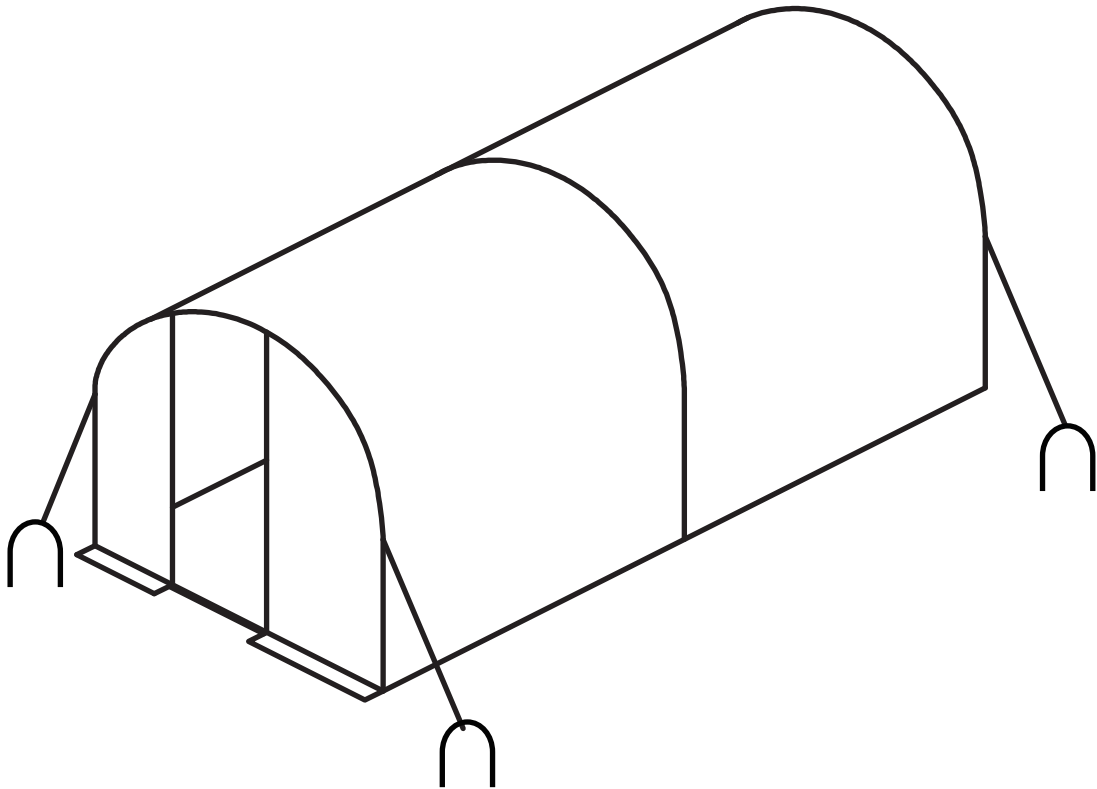

Instrucaction Manual

Tunnel-greenhouse



6mx3mx2m (Ref:SER-6)

6mx3mx2m (Ref:SER-6)

IMPORTANT

-Please read the entire assembly manual before using the product and then keep it for future reference

PRODUCT SAFETY

-Children should not play with the greenhouse

-Cleaning and maintenance should not be carried out by unsupervised children



-Do not use the greenhouse for purposes other than those for which it was designed

WARNING
-Bags can be dangerous. To avoid the risk of suffocation, keep packaging away from children and babies.





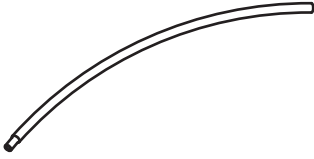
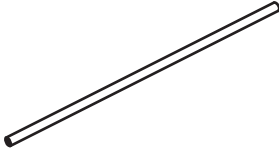
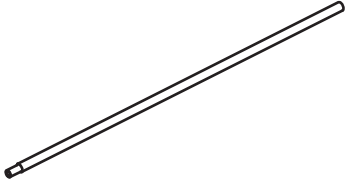
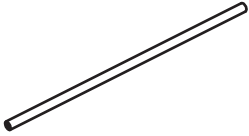
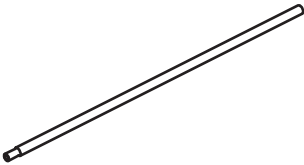
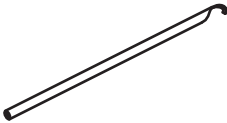
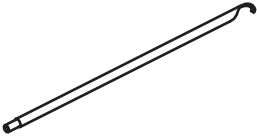
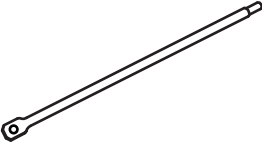

WARNING

-Bags can be dangerous. To avoid the risk of suffocation, keep packaging away from children and babies.

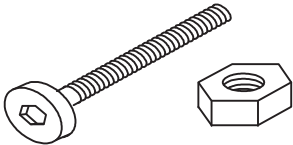
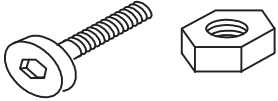
PART LIST

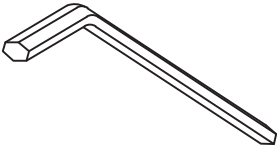
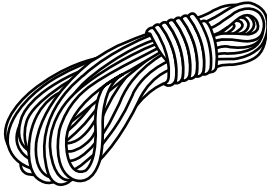
1.	2.	3.
		
QTY: 28 pcs	QTY: 6 pcs	QTY: 32 pcs
4.	5.	6.
		
QTY: 7 pcs	QTY: 7 pcs	QTY: 2 pcs
7.	8.	9.
		
QTY: 2 pcs	QTY: 2 pcs	QTY: 2 pcs

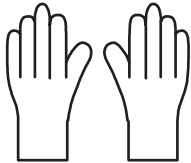
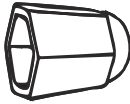
HARDWARE LIST

A.	B.	C.
		
QTY: 42 pcs	QTY: 13 pcs	QTY: 1 pcs
D.	E.	F.
		
QTY: 1 pcs	QTY: 4 pcs	QTY: 4 pcs
G.	H.	I.
		
QTY: 2 pcs	QTY: 37 pcs	QTY: 12 pcs

ASSEMBLY INSTRUCTIONS

STEP 1

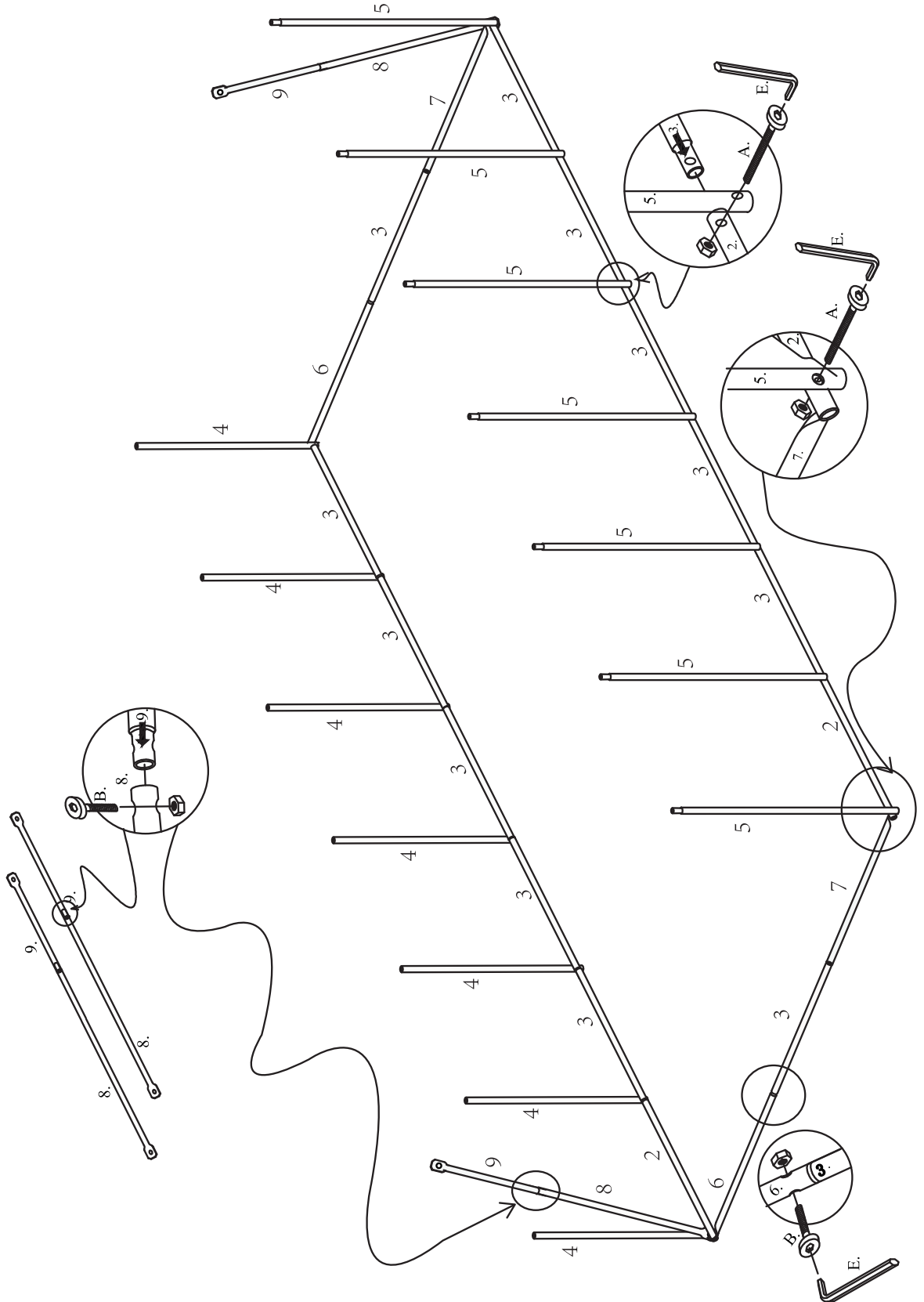

ASSEMBLY INSTRUCTIONS

STEP 2

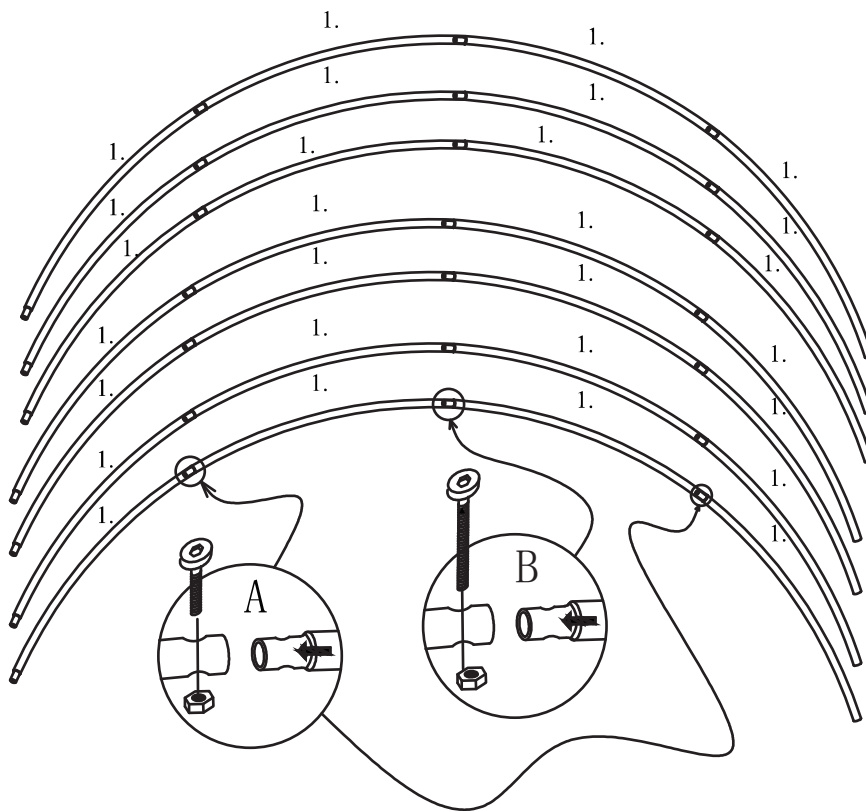

ASSEMBLY INSTRUCTIONS

STEP 3

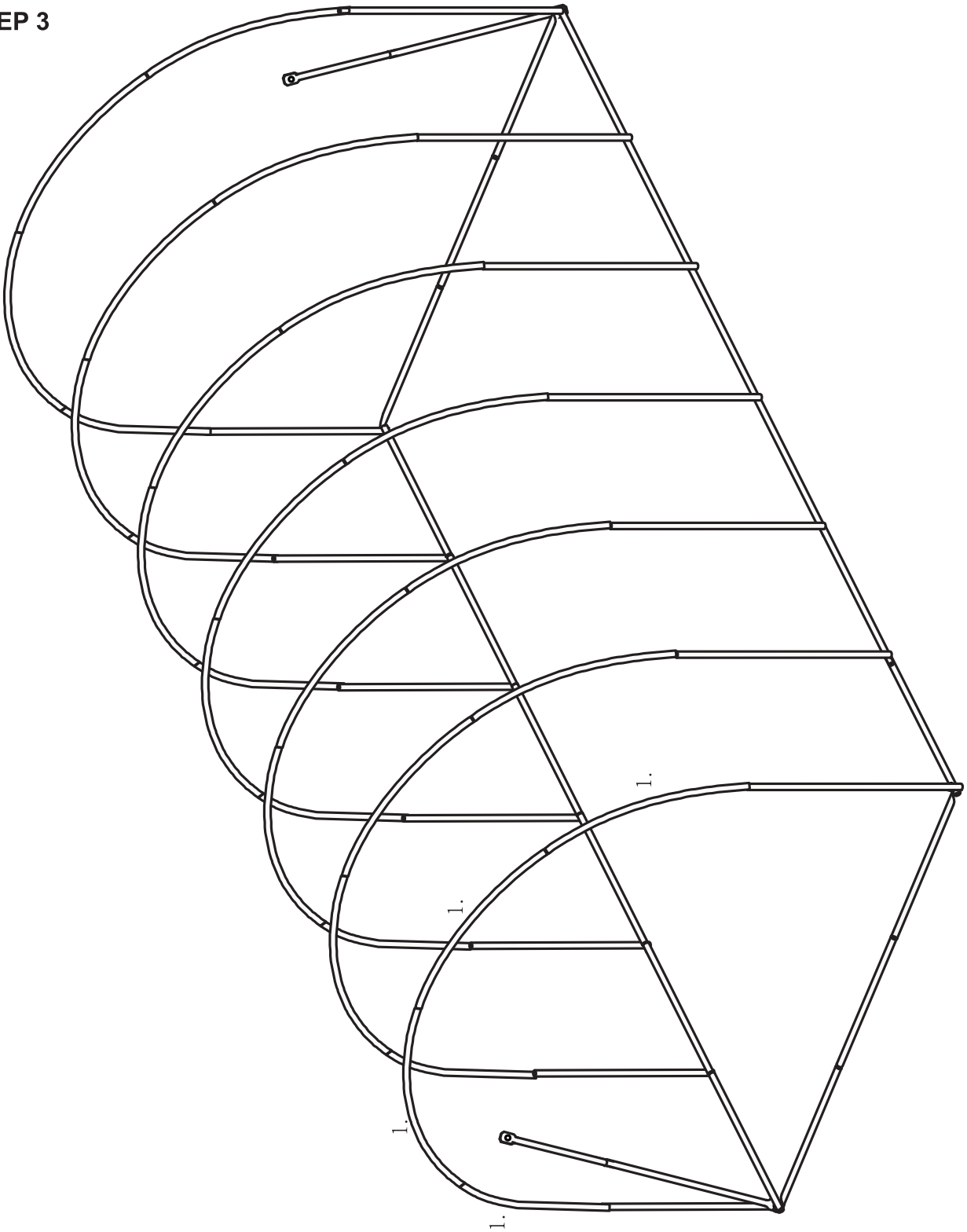

ASSEMBLY INSTRUCTIONS

STEP 4

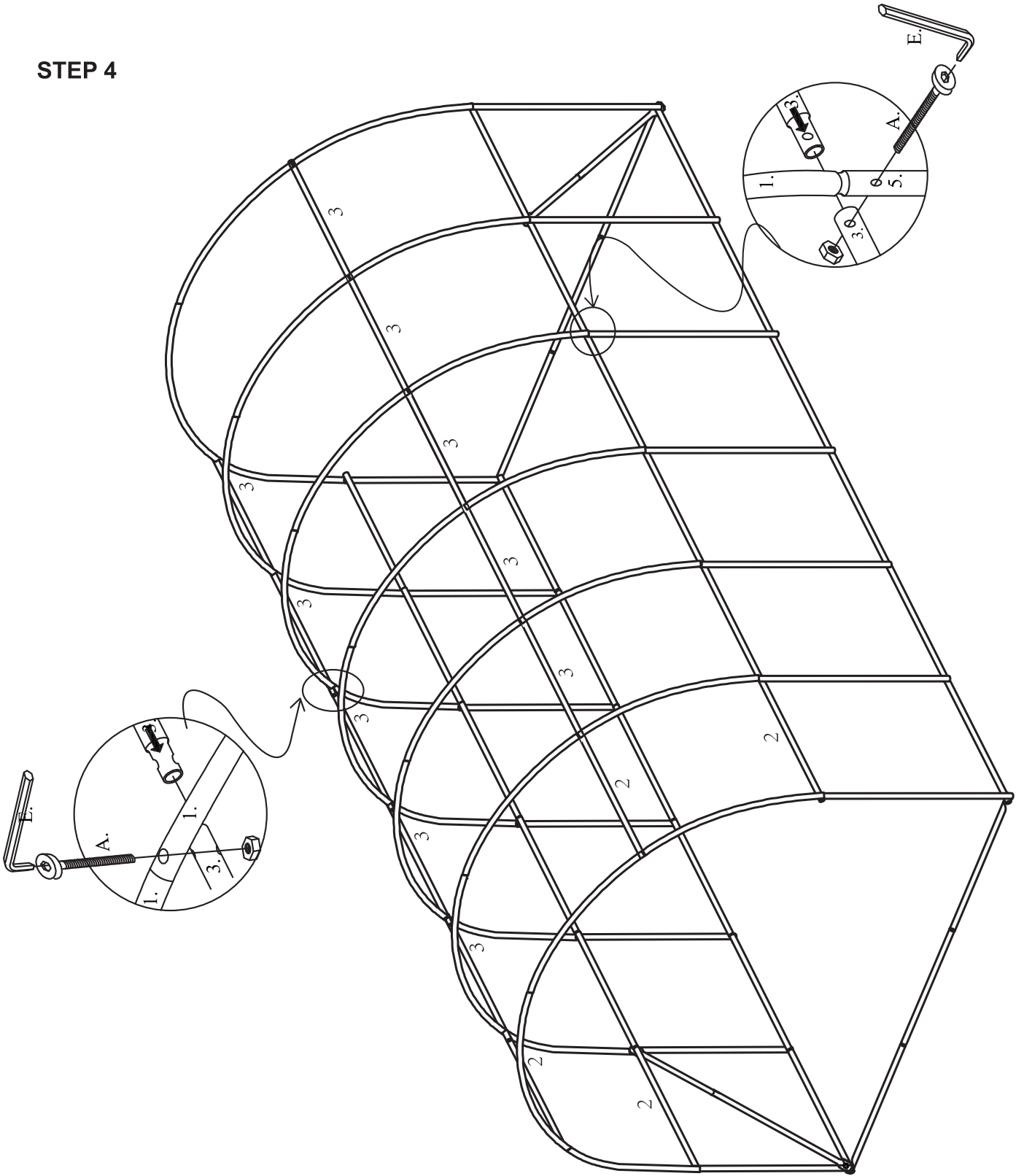

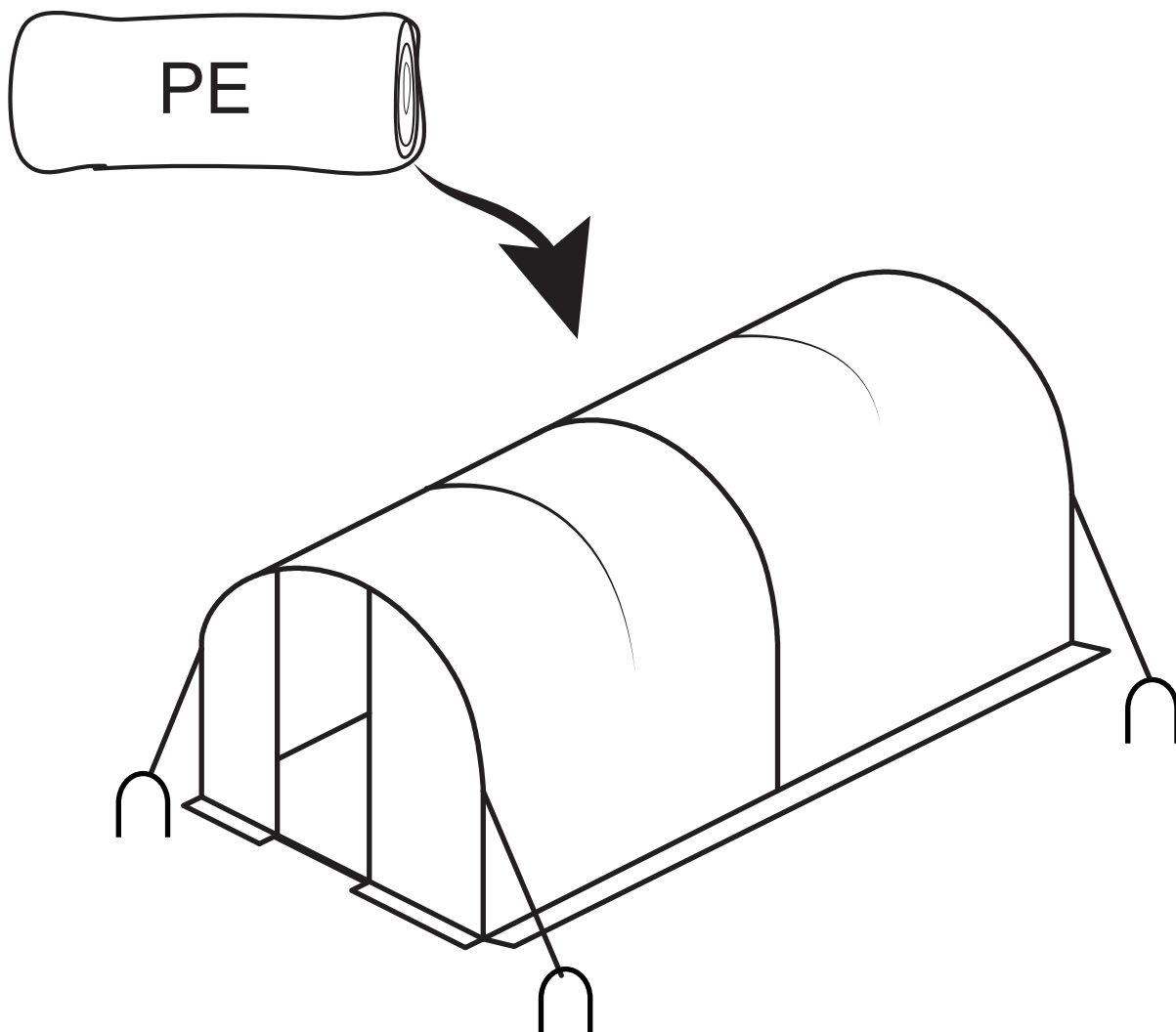

END