

WIKI 200

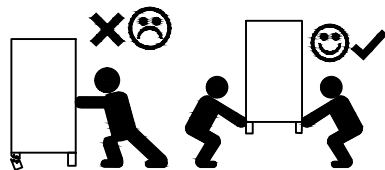

28.05.2021

- | | |
|----------------------------------|------------------------------|
| (D) Montageanleitung | (GB) Assembly Instructions |
| (FR) Notice de montage | (IT) Istruzioni di montaggio |
| (NL) Handleiding voor de montage | (PL) Instrukcja montażu |
| (CZ) Montážní návod | (SK) Návod na montáž |
| (HU) Szerelési útmutató | (RO) Instrucțiuni de montaj |
| (TR) Montaj talimatı | (RU) Инструкции по монтажу |

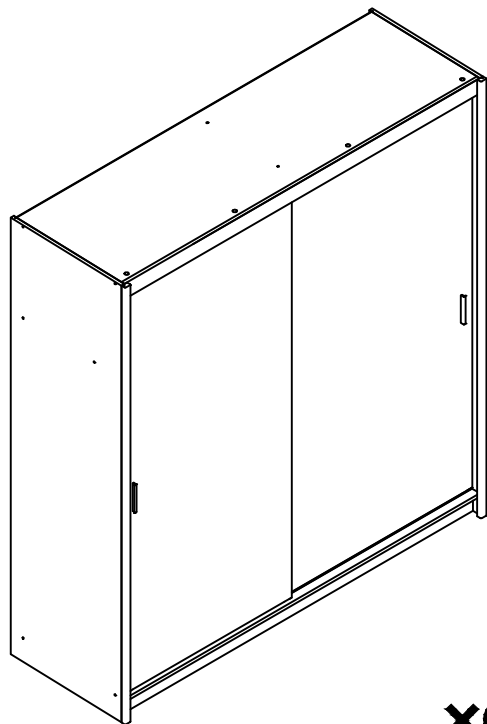
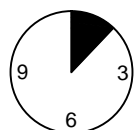
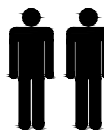

2-2,5

1

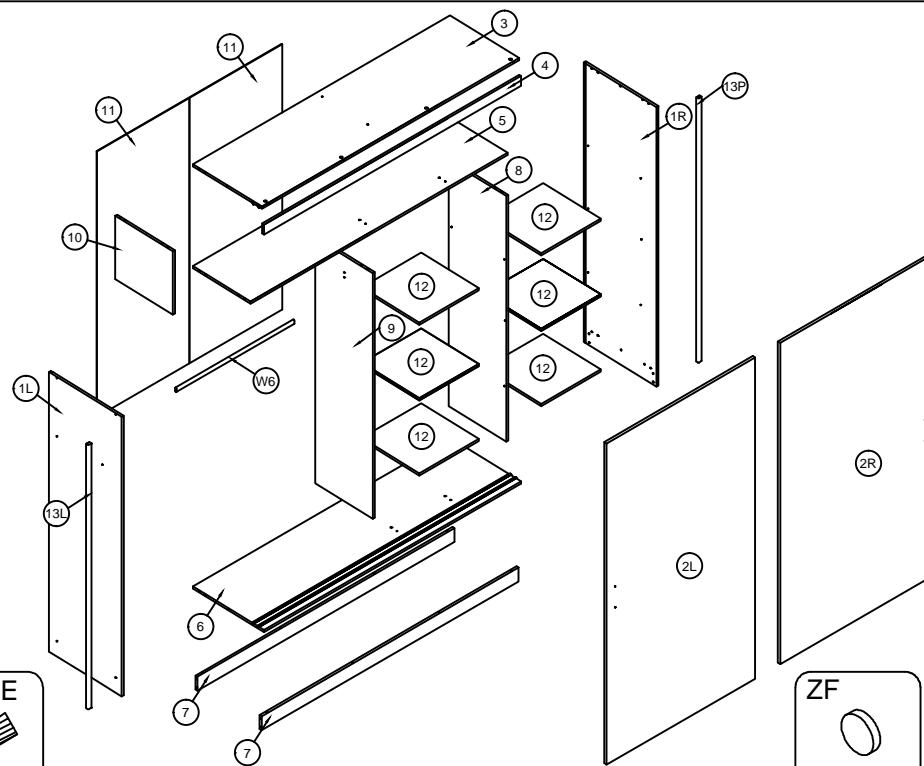

x1

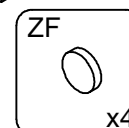

x4

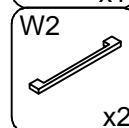

x2

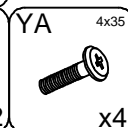

4x35

x4

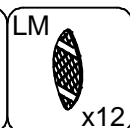

x12



3x13

x20



6,3x13

x16

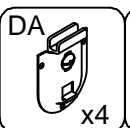

x4

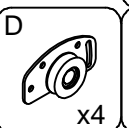

x4



L-1990mm

x2

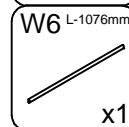

L-1076mm

x1

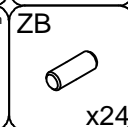

x24

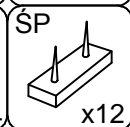

x12

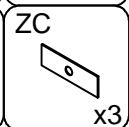

x3



3,5x16

x12



3x20

x70



7x50

x24

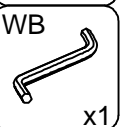

x1

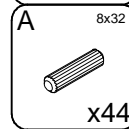

8x32

x44

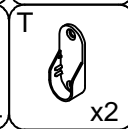

x2

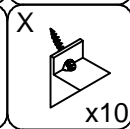

x10

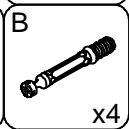

x4

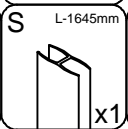

L-1645mm

x1

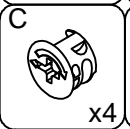

x4

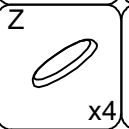

x4

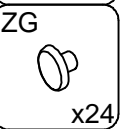

x24

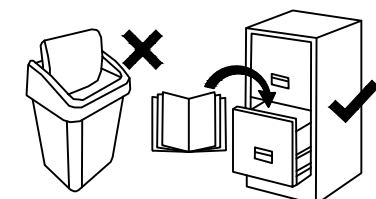
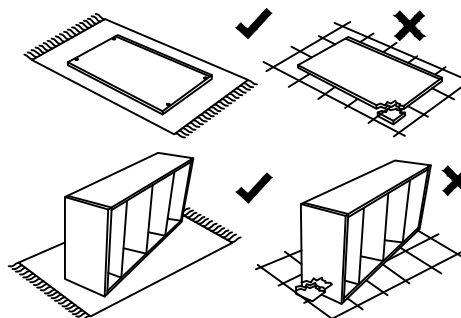

2

