

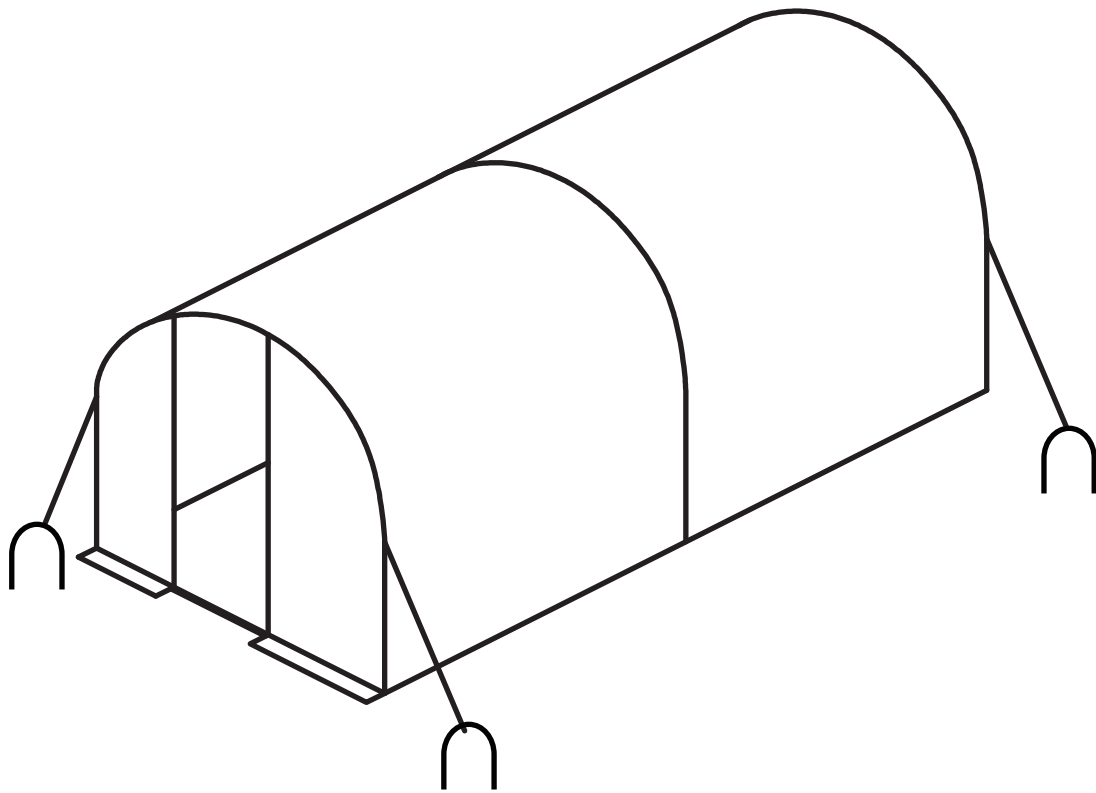

# **Instrucaction Manual**

## **Tunnel-greenhouse**



**3mx2mx2m (Ref:SER-5)**

# 3mx2mx2m (Ref:SER-5)

**IMPORTANT**

-Please read the entire assembly manual before using the product and then keep it for future reference

**PRODUCT SAFETY**

-Children should not play with the greenhouse

-Cleaning and maintenance should not be carried out by unsupervised children



-Do not use the greenhouse for purposes other than those for which it was designed

**WARNING**  
-Bags can be dangerous. To avoid the risk of suffocation, keep packaging away from children and babies.



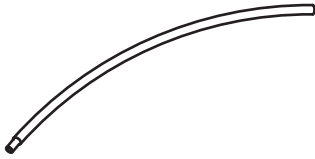
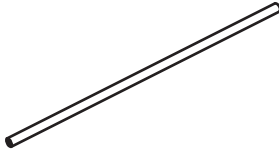
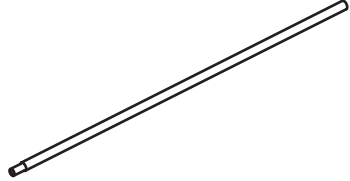
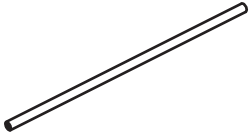
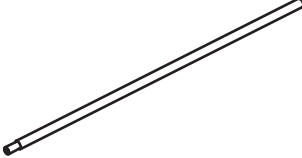
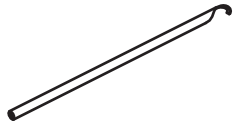
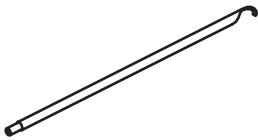
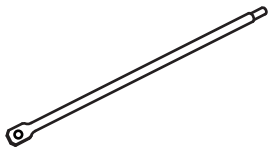

**WARNING**

-Bags can be dangerous. To avoid the risk of suffocation, keep packaging away from children and babies.

**PART LIST**

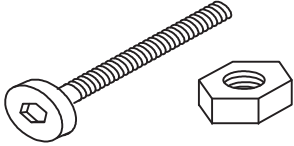
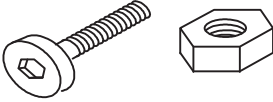
1.	2.	3.
		
QTY: 16 pcs	QTY: 5 pcs	QTY: 10 pcs
4.	5.	6.
		
QTY: 4 pcs	QTY: 4 pcs	QTY: 2 pcs
7.	8.	9.
		
QTY: 2 pcs	QTY: 2 pcs	QTY: 2 pcs

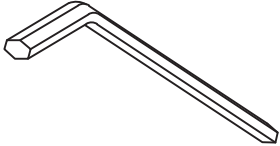
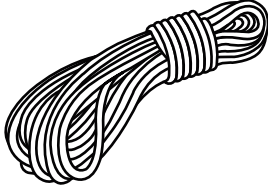
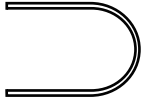
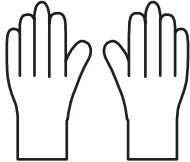
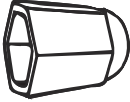
**HARDWARE LIST**

A.	B.	C.
		
QTY: 20 pcs	QTY: 12 pcs	QTY: 1 pcs
D.	E.	F.
		
QTY: 1 pcs	QTY: 4 pcs	QTY: 4 pcs
G.	H.	I.
		
QTY: 2 pcs	QTY: 22 pcs	QTY: 10 pcs

# ASSEMBLY INSTRUCTIONS

## STEP 1

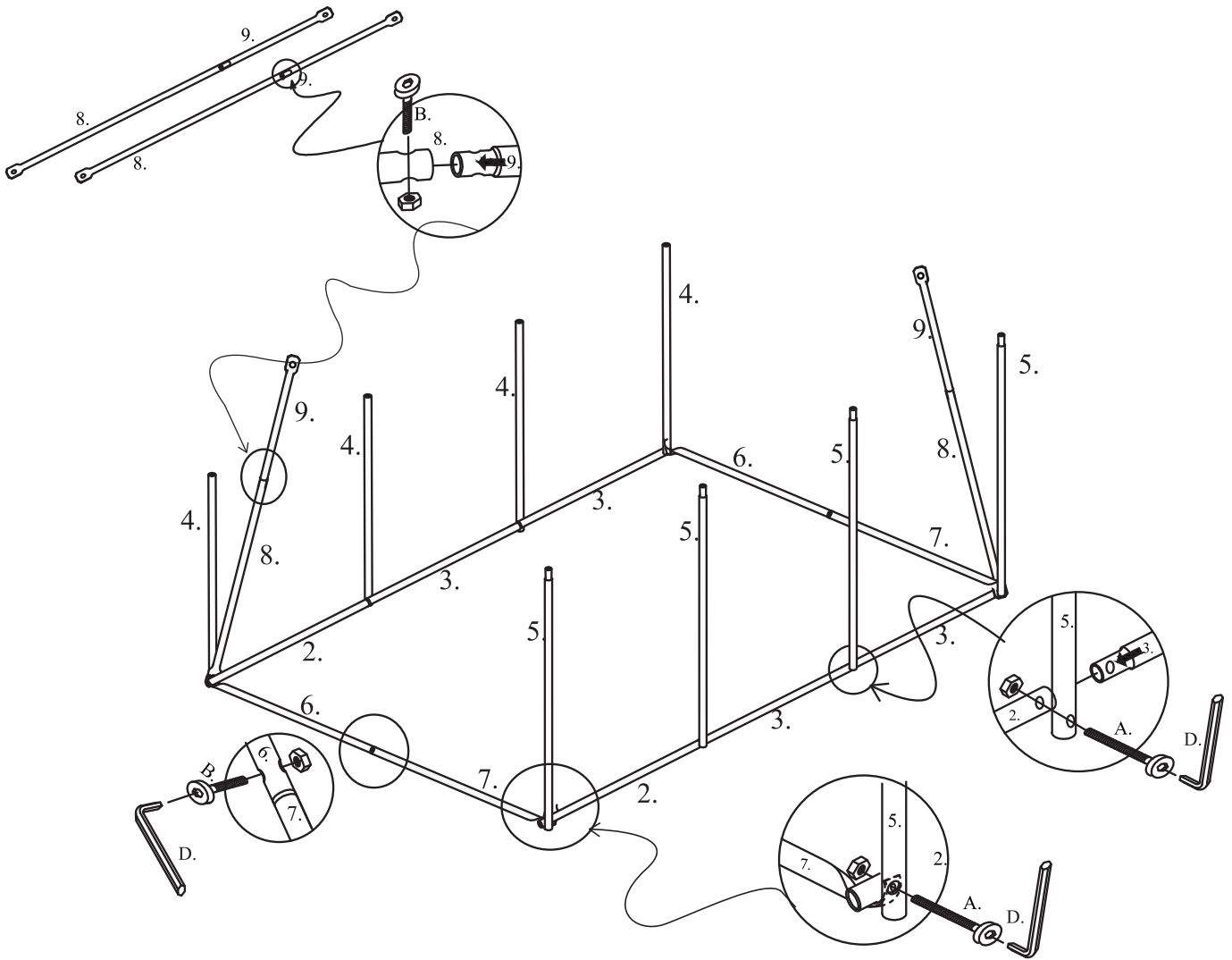

# ASSEMBLY INSTRUCTIONS

## STEP 2

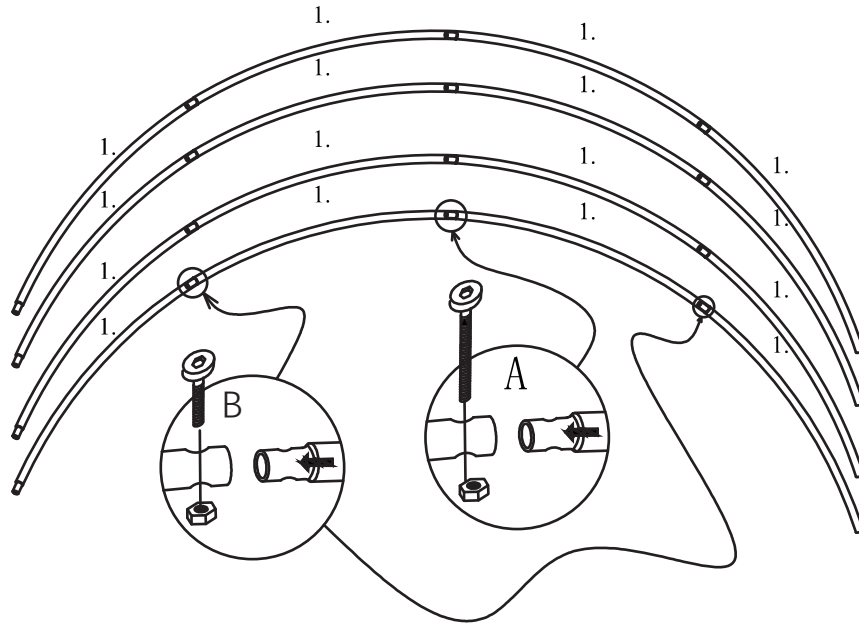

## STEP 3

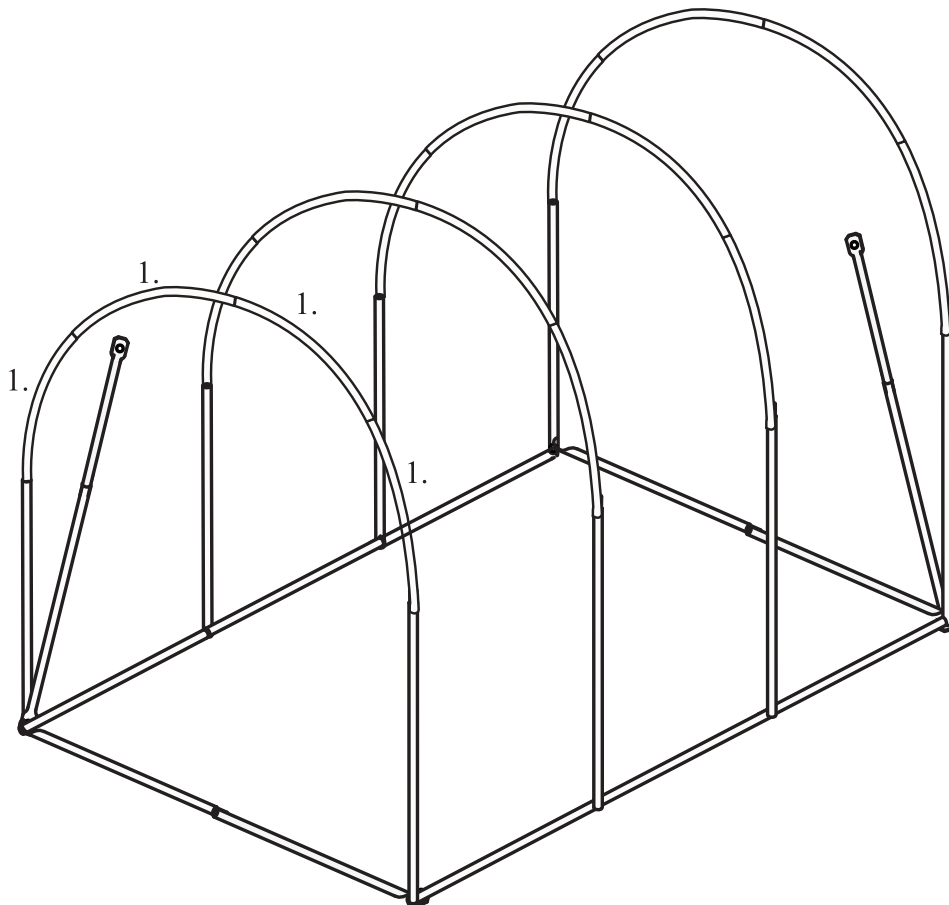

# ASSEMBLY INSTRUCTIONS

## STEP 4

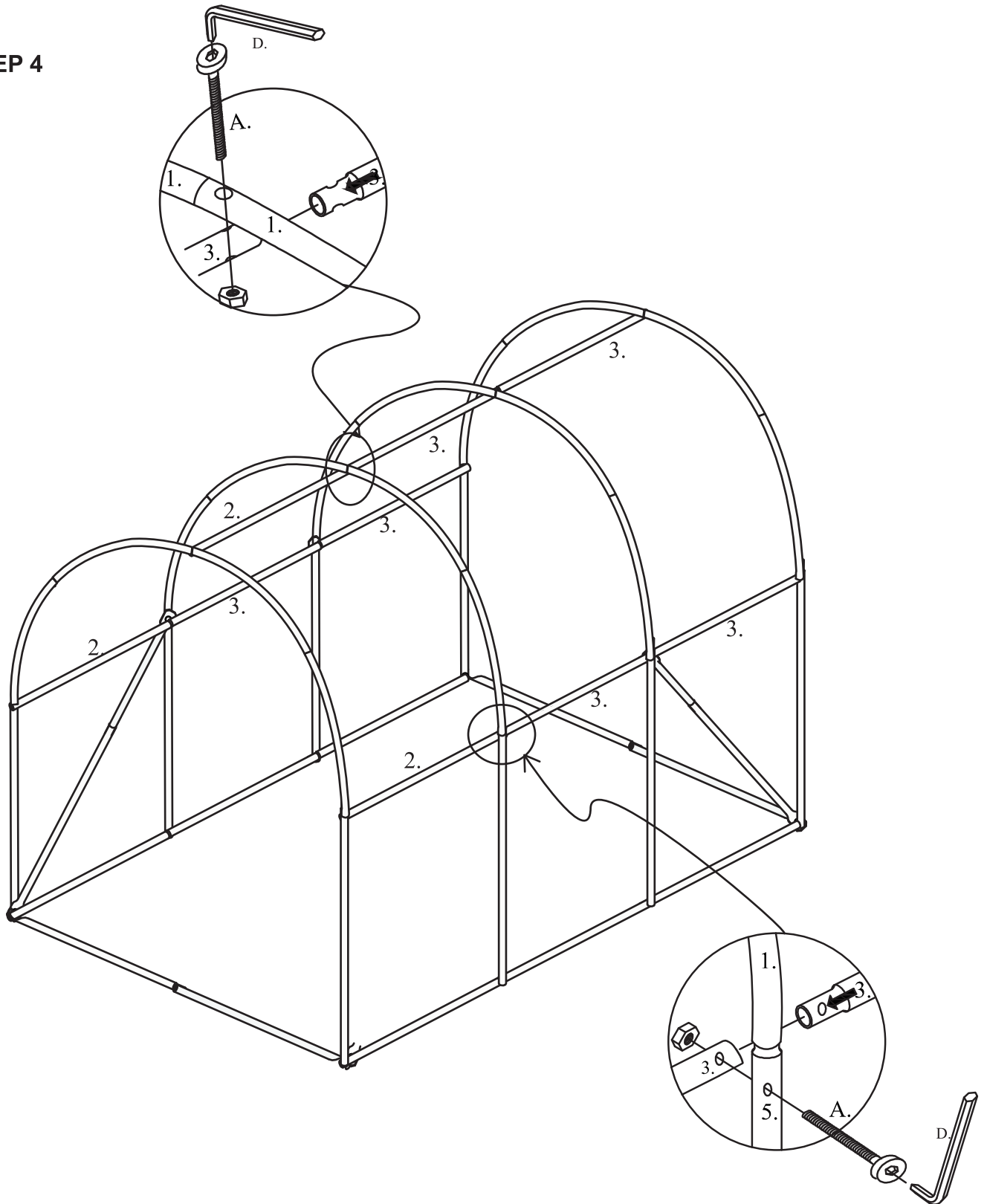

ASSEMBLY INSTRUCTIONS

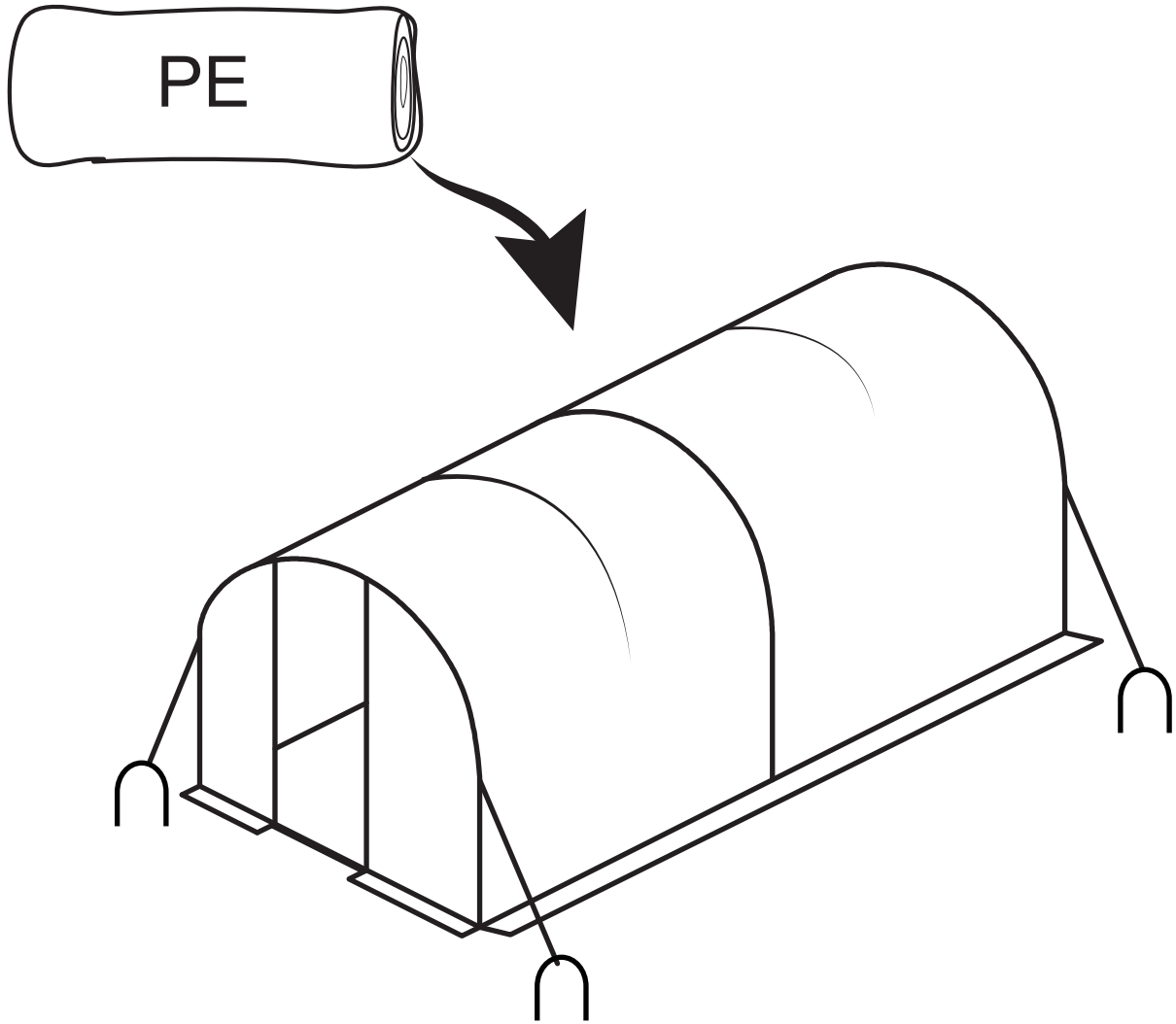

**END**